



OPERATOR'S MANUAL

A Division of Snow Joe®, LLC

CORDLESS INFLATOR+DEFLATOR – TOOL ONLY

24-VOLT MAX* | INFLATION ADAPTERS

Model 24V-AJV-CT-RM

Form No. 24V-AJV-CT-RM-880E-MR1-V2

THANKS FOR YOUR PURCHASE OF A REMANUFACTURED PRODUCT.

To make sure you get the most out of your product, be sure to register online at

sunjoe.com

to enjoy full product support.

PASTE UPC LABEL HERE



OPERATOR'S MANUAL

A Division of Snow Joe®, LLC

CORDLESS INFLATOR+DEFLATOR – TOOL ONLY

24-VOLT MAX* | INFLATION ADAPTERS

Model 24V-AJV-CT-RM

Form No. 24V-AJV-CT-RM-880E-MR1-V2

IMPORTANT!

Safety Instructions

All Operators Must Read These Instructions Before Use

Always follow these safety guidelines. Failure to do so may result in serious bodily injury or death.

General Power Tool Safety Warnings

⚠ WARNING Read all safety warnings and all instructions. Failure to follow the warnings and instructions may result in electric shock, fire and/or serious injury.

Save all warnings and instructions for future reference.

⚠ DANGER! This indicates a hazardous situation, which, if not followed, will result in serious injury or death.

⚠ WARNING! This indicates a hazardous situation, which, if not followed, could result in serious injury or death.

⚠ CAUTION! This indicates a hazardous situation, which, if not followed, could result in minor or moderate injury.

Work Area Safety

1. **Keep work area clean and well-lit** – Cluttered, dark areas invite accidents.
2. **Keep children, bystanders, and pets away** – All spectators, including pets, should be kept a safe distance away from the work area.
3. **Operate cordless high volume inflator in an open area at least 18 in. (45.7 cm) away from any wall or object that could restrict the flow air to ventilation openings.**

Electrical Safety

1. **To reduce the risk of electrical shock, do not put inflator in water or other liquid.** Do not place or store appliance where it can fall or be pulled into a tub or sink.
2. **Recharge only with the charger specified by the manufacturer.** A charger that is suitable for one type of battery pack may create a risk of fire when used with another battery pack.

Personal Safety

1. **Stay alert** – Watch what you are doing. Use common sense. Do not operate the cordless high volume inflator when you are tired, or under the influence of alcohol or drugs.
2. **Dress properly** – Do not wear loose clothing or jewelry. They can get caught in moving parts. Loose clothes, jewelry, or long hair can be caught in moving parts.
3. **Avoid unintentional starting** – Do not carry the cordless high volume inflator with your finger on the trigger.
4. **Do not overreach** – Keep proper footing and balance at all times. Proper footing and balance enable better control of the cordless high volume inflator in unexpected situations.
5. **Use safety equipment** – Always wear eye protection. Dust mask, non-skid safety shoes, hard hat, or hearing protection must be used for appropriate conditions.
6. **Eye protection is required to guard against flying fasteners and debris which could cause severe eye injury.**
7. **Do not wear loose clothing or jewelry** – Contain long hair. Loose clothes, jewelry, or long hair can be drawn into air vents.
8. **Do not use on a ladder or unstable support** – Stable footing on a solid surface enables better control of the cordless high volume inflator in unexpected situations.
9. **Do not force the tool** – It will perform better with less likelihood of personal or mechanical injury if it is used at the rate for which it was designed.
10. **Release all pressures within the system slowly.** Dust and debris may be harmful.
11. **Do not use cordless high volume inflator if switch does not turn it on or off.** The cordless high volume inflator that cannot be controlled with the switch is dangerous and must be repaired.
12. **Disconnect battery pack from the cordless high volume inflator before making any adjustments, changing accessories, or storing the cordless high volume inflator.** Such preventive safety measures reduce the risk of starting the cordless high volume inflator accidentally.
13. **Store idle cordless high volume inflator out of reach of children or other untrained persons.** Cordless high volume inflators are dangerous in the hands of untrained users.

14. **When battery pack is not in use, keep it away from metal objects like: paper clips, coins, keys, nails, screws, or other small metal objects that can make a connection from one terminal to another.** Shorting the battery terminals together may cause sparks, burns, or a fire.
15. **Check for misalignment or binding of moving parts, breakage of parts, and any other condition that may affect the cordless high volume inflator's operation. If damaged, have the cordless high volume inflator serviced before using.** Many accidents are caused by poorly maintained tools.
16. **Use only accessories that are recommended by the manufacturer for your model.** Accessories that may be suitable for one cordless high volume inflator may create a risk of injury when used on another cordless high volume inflator.
17. **Keep the cordless high volume inflator and its handle dry, clean and free from oil and grease.** Always use a clean cloth when cleaning. Never use brake fluid, gasoline, petroleum-based products, or any strong solvents to clean your cordless high volume inflator. Following this rule will reduce the risk of loss of control and deterioration of the enclosure plastic.
18. **Never point any cordless high volume inflator toward yourself or others.**
19. **Do not exceed the pressure rating of any component in the system.**
7. **Remove the battery** – Remove the battery from the cordless high volume inflator when it is not in use, before servicing it, when changing accessories, and when performing any other maintenance task.
8. **Protect your lungs** – Wear a face or dust mask if the operation is dusty. Following this rule will reduce the risk of serious personal injury.
9. Do not use cordless high volume inflator as a breathing device.
10. Never direct a jet of compressed air toward people or animals. Take care not to blow dust and dirt towards yourself or others. Following this rule will reduce the risk of serious injury.
11. Do not use this cordless high volume inflator to spray chemicals. Your lungs can be damaged by inhaling toxic fumes.
12. Always be aware that misuse and improper handling of this cordless high volume inflator can cause injury to yourself and others.
13. Do not continue to use a cordless high volume inflator that leaks air or does not functions properly.
14. Always follow all safety rules recommended by the manufacturer of your cordless high volume inflator, in addition to all safety rules for the cordless air inflator. Following this rule will reduce the risk of serious personal injury.
15. Do not crush, drop or damage battery pack. Do not use a battery pack or charger that has been dropped or received a sharp blow. A damaged battery is subject to explosion. Properly dispose of a dropped or damaged battery immediately.
16. Do not charge battery tool in a damp or wet location. Following this rule will reduce the risk of electric shock.
17. Inspect tool cords periodically and, if damages, have repaired at your nearest authorized service center. Constantly stay aware of cord location. Following this rule will reduce the risk of electric shock or fire.

Specific Safety Warnings for Cordless High volume inflator

1. **Know your cordless high volume inflator** – Know how to start and stop the tool. Be thoroughly familiar with the controls.
2. **Risk of bursting** – Do not preset cordless high volume inflator to result in output pressure greater than marked maximum pressure of item to be inflated. Do not use at pressure greater than 0.65 PSI.
3. To reduce the risk of electric shock, do not expose to rain. Store indoors.
4. **Inspect yearly for cracks, pin holes, or other imperfections that could cause cordless high volume inflator to become unsafe.** Never cut or drill holes in the high volume inflator.
5. **Use the right appliance** – Do not use the cordless high volume inflator for any applications other than those for which it was intended.
6. **Check for damaged parts** – Before further use of the cordless high volume inflator or air tool, all guards and parts should be carefully checked to determine that it will operate properly and perform its intended function. Check for alignment of moving parts, binding of moving parts, breakage of parts, mounting, and any other condition that may affect its operation. A guard or other part that is damaged should be properly repaired or replaced. Contact the Snow Joe® + Sun Joe® customer service center at 1-866-SNOWJOE (1-866-766-9563) for assistance.

 **WARNING!** Do not use this cordless high volume inflator without reading this instruction manual. For indoor use only.

Battery & Charger Safety Instructions

NOTE: This unit is the tool only. The battery and the charger are not included. They must be purchased separately.

Model 24V-AJV-CT-RM is compatible with the iON+ 24V System batteries and chargers. See page 14 for more information.

We pay a great deal of attention to the design of every battery pack to ensure that we supply you with batteries that are safe, durable and have a high energy density. The battery cells have a wide range of safety devices. Each individual cell is initially formatted and its electrical characteristic curves are recorded. This data is then used exclusively to be able to assemble the best possible battery packs.

Despite all the safety precautions, caution must always be exercised when handling batteries. The following points must be obeyed at all times to ensure safe use. Safe use can only be guaranteed if undamaged cells are used. Incorrect handling of the battery pack can cause cell damage.

IMPORTANT! Analyses confirm that incorrect use and poor care of high-performance batteries are the main factors responsible for personal and/or product damage.

⚠️ WARNING! Use only approved replacement batteries; other batteries may damage the power tool and cause it to malfunction, which can lead to serious personal injury.

⚠️ WARNING! Do not use a battery pack or appliance that is damaged or modified. Damaged or modified batteries may exhibit unpredictable behavior resulting in fire, explosion or risk of injury.

Do not modify or attempt to repair the appliance or the battery pack except as indicated in the instructions for use and care.

Have your battery pack serviced by a qualified repair person using only identical replacement parts. This will ensure that the safety of the battery pack is maintained.

⚠️ CAUTION! To reduce the risk of injury, charge the iON+ 24V lithium-ion battery pack only in its designated iON+ 24V lithium-ion charger. Other types of chargers present risk of fire, personal injury and damage. Do not wire a battery pack to a power supply plug or car cigarette lighter. Such misuse will permanently disable or damage the battery pack.

- **Avoid dangerous environments** – Do not charge the battery pack in rain, snow or in damp or wet locations. Do not use the battery pack or charger in the presence of explosive atmospheres (gaseous fumes, dust or flammable materials) because sparks may be generated when inserting or removing the battery pack, which could lead to a fire.
- **Charge in a well-ventilated area** – Do not block the charger vents. Keep them clear to allow for proper ventilation. Do not allow smoking or open flames near a charging battery pack. Vented gases may explode.

NOTE: The safe temperature range for the battery is 41°F – 105°F (5°C – 40.5°C). Do not charge the battery outside in freezing weather; charge it at room temperature.

- **Maintain charger cord** – When unplugging the charger, pull the plug, not the cord, from the receptacle to reduce the risk of damage to the electrical plug and cord. Never carry the charger by its cord or yank it by the cord to disconnect it from the receptacle. Keep the cord away from heat, oil and sharp edges. Make sure the cord will not be stepped on, tripped over or subjected to damage or stress when the charger is in use. Do not use the charger with a damaged cord or plug. Replace a damaged charger immediately.
- **Do not use an extension cord unless it is absolutely necessary** – Using the wrong, damaged or improperly wired extension cord poses a risk of fire and electric shock. If an extension cord must be used, plug the charger into a properly wired 16 gauge or larger extension cord with the female plug matching the male plug on the charger. Make sure that the extension cord is in good electrical condition.

- **Check the rated input for the charger before using** – The charger must be plugged into an appropriate receptacle.
- **Use only recommended attachments** – Use of an attachment not recommended or sold by the battery charger or battery pack manufacturer may result in risk of fire, electric shock or personal injury.
- **Unplug charger when not in use** – Make sure to remove battery packs from unplugged chargers.

⚠️ WARNING! To reduce the risk of electric shock, always unplug the charger before performing any cleaning or maintenance. Do not allow water to flow into the charger. Use a Ground Fault Circuit Interrupter (GFCI) to reduce shock hazards.

- **Do not burn or incinerate battery packs** – Battery packs may explode, causing personal injury or damage. Toxic fumes and materials are created when battery packs are burned.
- **Do not crush, drop or damage battery packs** – Do not use the battery pack or charger if they have sustained a sharp blow, been dropped, run over or have been damaged in any way (i.e. pierced with a nail, hit with a hammer, stepped on, etc.).
- **Do not disassemble** – Incorrect reassembly may pose a serious risk of electric shock, fire or exposure to toxic battery chemicals. If the battery or charger are damaged, contact an authorized Snow Joe® + Sun Joe® dealer or call the Snow Joe® + Sun Joe® customer service center at 1-866-SNOWJOE (1-866-766-9563) for assistance.
- **Battery chemicals cause serious burns** – Never let a damaged battery pack contact the skin, eyes or mouth. If a damaged battery pack leaks battery chemicals, use rubber or neoprene gloves to safely dispose of it. If skin is exposed to battery fluids, wash the affected area with soap and water and rinse with vinegar. If eyes are exposed to battery chemicals, immediately flush with water for 20 minutes and seek medical attention. Remove and dispose of contaminated clothing.
- **Do not short circuit** – When battery pack is not in use, keep it away from other metal objects, like paper clips, coins, keys, nails, screws or other small metal objects, that can make a connection from one terminal to another. Shorting the battery terminals together may cause burns or a fire.
- **Store your battery pack and charger in a cool, dry place** – Do not store the battery pack or charger where temperatures may exceed 105°F (40.5°C), such as in direct sunlight or inside a vehicle or metal building during the summer.

Information about the battery

1. The battery pack is only partially charged. The battery pack has to be charged completely before you use the tool for the first time.
2. For optimum battery performance, avoid low discharge cycles by charging the battery pack frequently.
3. Store the battery pack in a cool place, ideally at 59°F (15°C) and charged to at least 40%.
4. Lithium-ion batteries are subject to a natural aging process. The battery pack must be replaced at the latest when its capacity falls to just 80% of its capacity when new. Weakened cells in an aged battery pack are no longer capable of meeting the high power requirements needed for the proper operation of your cordless high volume inflator, and therefore pose a safety risk.
5. Do not throw battery packs into an open fire as this poses a risk of explosion.
6. Do not ignite the battery pack or expose it to fire.
7. Do not exhaustively discharge batteries. Exhaustive discharge will damage the battery cells. The most common cause of exhaustive discharge is lengthy storage or non-use of partially discharged batteries. Stop working as soon as the performance of the battery falls noticeably or the electronic protection system triggers. Place the battery pack in storage only after it has been fully charged.
8. Protect batteries and the tool from overloads. Overloads will quickly result in overheating and cell damage inside the battery housing even if this overheating is not apparent externally.
9. Avoid damage and shocks. Immediately replace batteries that have been dropped from a height of more than 3 feet (1 meter) or those that have been exposed to violent shocks, even if the housing of the battery pack appears to be undamaged. The battery cells inside the battery may have suffered serious damage. In such instances, please read the waste disposal information for proper battery disposal.
10. If the battery pack suffers overloading and overheating, the integrated protective cutoff will switch off the equipment for safety reasons.

IMPORTANT! Do not press the ON/OFF switch any more if the protective cut-off has been activated. This may damage the battery pack.

11. Recharge only with the charger specified by the manufacturer. A charger that is suitable for one type of battery pack may create a risk of fire when used with another battery pack.
12. Use appliances only with specifically designated battery packs. Use of any other battery packs may create a risk of injury and fire.
13. Under abusive conditions, liquid may be ejected from the battery; avoid contact. If contact accidentally occurs, flush with water. If liquid contacts eyes, additionally seek medical help. Liquid ejected from the battery may cause irritation or burns.
14. Do not use a battery pack or appliance that is damaged or modified. Damaged or modified batteries may exhibit unpredictable behavior resulting in fire, explosion or risk of injury.
15. Do not expose a battery pack or appliance to fire or excessive temperature. Exposure to fire or temperature above 266°F (130°C) may cause explosion.
16. Follow all charging instructions and do not charge the battery pack or appliance outside of the temperature range specified in the instructions. Charging improperly or at temperatures outside of the specified range may damage the battery and increase the risk of fire.

Information about the charger and the charging process

1. Please check the data marked on the rating plate of the battery charger. Be sure to connect the battery charger to a power supply with the voltage marked on the rating plate. Never connect it to a different mains voltage.
2. Protect the battery charger and its cord from damage. Keep the charger and its cord away from heat, oil and sharp edges. Have damaged cords repaired without delay by a qualified technician at an authorized Snow Joe® + Sun Joe® dealer or call the Snow Joe® + Sun Joe® customer service center at 1-866-SNOWJOE (1-866-766-9563).
3. Electrical plugs must match the outlet. Never modify the plug in any way. Do not use any adapter plugs with grounded appliances. Unmodified plugs and matching outlets will reduce the risk of electric shock.
4. Keep the battery charger, battery pack(s) and the cordless tool out of the reach of children.
5. Do not use the supplied battery charger to charge other cordless tools.
6. During periods of heavy use, the battery pack will become warm. Allow the battery pack to cool to room temperature before inserting it into the charger to recharge.
7. Do not overcharge batteries. Do not exceed the maximum charging times. These charging times only apply to discharged batteries. Frequent insertion of a charged or partially charged battery pack will result in overcharging and cell damage. Do not leave batteries in the charger for days on end.
8. Never use or charge batteries if you suspect that it has been more than 12 months since the last time they were charged. There is a high probability that the battery pack has already suffered dangerous damage (exhaustive discharge).
9. Charging batteries at a temperature below 41°F (5°C) will cause chemical damage to the cells and may cause a fire.
10. Do not use batteries that have been exposed to heat during the charging process, as the battery cells may have suffered dangerous damage.
11. Do not use batteries that have suffered curvature or deformation during the charging process or those that exhibit other atypical symptoms (gassing, hissing, cracking, etc.).







12. Never fully discharge the battery pack (maximum recommended depth of discharge is 80%). A complete discharge of the battery pack will lead to premature aging of the battery cells.

Protection from environmental influences

1. Wear suitable work clothes. Wear safety goggles.
2. Protect your cordless tool and the battery charger from moisture and rain. Moisture and rain can cause dangerous cell damage.
3. Do not use the cordless tool or the battery charger near vapors and flammable liquids.
4. Use the battery charger and cordless tools only in dry conditions and at an ambient temperature of 41°F – 105°F (5°C – 40.5°C).
5. Do not keep the battery charger in places where the temperature is liable to reach over 105°F (40.5°C). In particular, do not leave the battery charger in a car that is parked in the sunshine.
6. Protect batteries from overheating. Overloads, overcharging and exposure to direct sunlight will result in overheating and cell damage. Never charge or work with batteries that have been overheated – replace them immediately, if possible.
7. Store the charger and your cordless tool only in dry locations with an ambient temperature of 41°F – 105°F (5°C – 40.5°C). Store your lithium-ion battery pack in a cool, dry place at a temperature of 77°F (25°C). Protect the battery pack, charger and cordless tool from humidity and direct sunlight. Only place fully charged batteries in storage (charged to at least 40%).
8. Prevent the lithium-ion battery pack from freezing. Battery packs that were stored below 32°F (0°C) for more than 60 minutes must be discarded.
9. When handling batteries, be wary of electrostatic charge. Electrostatic discharges can damage the electronic protection system and the battery cells. Avoid electrostatic charging and never touch the battery poles.

Safety Symbols

The following table depicts and describes safety symbols that may appear on this product. Read, understand, and follow all instructions on the machine before attempting to assemble and operate.

Symbols	Descriptions	Symbols	Descriptions
	READ THE OPERATOR'S MANUAL(S) – Read, understand, and follow all instructions in the user manual(s) before attempting to assemble and operate.		SAFETY ALERT – Indicates a precaution, a warning, or a danger.
	Indoor use only. Only use battery charger indoors.		WEAR EYE PROTECTION – For protection against injury, wear safety goggles.
	WET CONDITIONS ALERT – Do not expose to rain or use in damp locations.		HOT SURFACE – To reduce the risk of injury or damage, avoid contact with any hot surface.

Know Your Cordless High Volume Inflator

Read the owner’s manual and safety instructions carefully before operating the cordless high volume inflator. Compare the illustration below to the cordless high volume inflator in order to familiarize yourself with the location of the various controls and adjustments. Save this manual for future reference.

- 1. Small Adapter
- 2. Medium Adapter
- 3. Large Adapter
- 4. Deflation Port
- 5. Inflation Port
- 6. ON/OFF Trigger
- 7. Battery Compartment

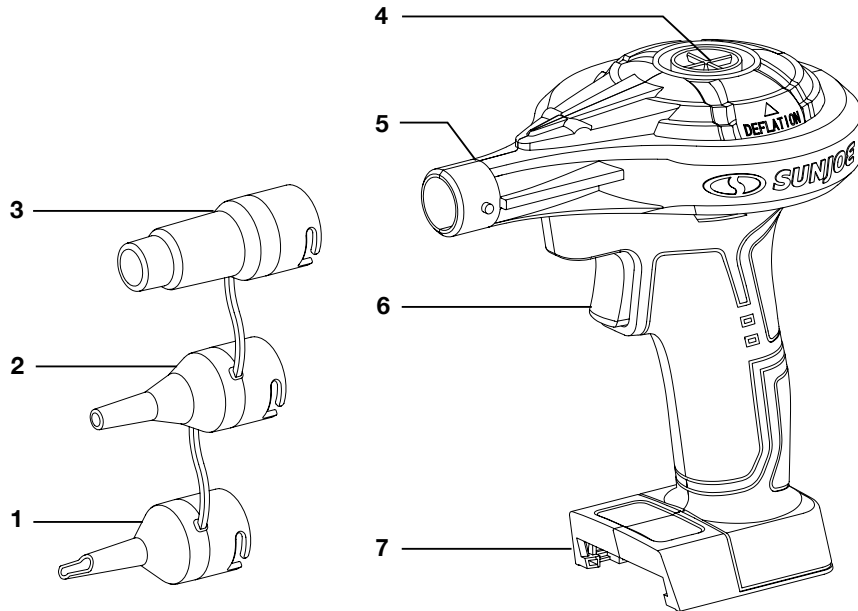

SOLD SEPARATELY			Battery + Charger options available at sunjoe.com	
24VBAT-LTE	24VBAT-LT	24VBAT	24VCHRG-QC	24VCHRG-DPC

Technical Data

Motor	150 W	Air Flow Max	36 CFM (1 m ³ /min)
Battery Voltage Max*	24V D.C.	Inflation Adapter Diameters	0.17 in (4.3 mm)
Working Air Pressure Max	0.65 PSI, 0.04 BAR		0.19 in (4.8 mm)
	<i>(Inflation time varies by item)</i>		0.5 in (13 mm)
Air Pressure Max	0.7 PSI, 0.05 BAR	Net Weight	1 lb (0.46 kg)
Air Speed Max.....	188.8 MPH (303.8 km/h)		

*Initial no-load voltage, when fully charged, peaks at 24 volts; nominal voltage under typical load is 21.6 volts.

Unpacking

Carton Contents

- Cordless high volume inflator
- Inflation adapters (x3, attached)
- Manual with registration card

NOTE: In order to operate this cordless high volume inflator you will need iON+ 24V System batteries and chargers. See page 13 for battery options and specifications, or visit sunjoe.com.

1. Carefully remove the high volume inflator and check to see that all of the above items are supplied.
2. Inspect the product carefully to make sure no breakage or damage occurred during shipping. If you find damaged or missing parts, DO NOT return the unit to the store. Please call the Snow Joe® + Sun Joe® customer service center at 1-866-SNOWJOE (1-866-766-9563).

NOTE: Do not discard the shipping carton and packaging material until you are ready to use your new cordless high volume inflator. The packaging is made of recyclable materials. Properly dispose of these materials in accordance with local regulations.

IMPORTANT! The equipment and packaging material are not toys. Do not let children play with plastic bags, foils, or small parts. These items can be swallowed and pose a suffocation risk!

Battery Pack Operation

The equipment is powered by a lithium-ion battery. The battery pack is completely sealed and maintenance free.





TOOL ONLY
BATTERY + CHARGER SOLD SEPARATELY

In order to operate this cordless high volume inflator you will need an iON+ 24V System battery and charger. See page 14 for battery and charger options and specifications, or for more information visit sunjoe.com.

Battery Charge Level Indicator

The battery pack is equipped with a push button for checking the charge level. Simply press the push button to read off the battery charge level from the LEDs of the battery indicator:

- All 3 level monitoring LEDs are lit: Battery charge level is high.
- 2 level monitoring LEDs are lit: Battery charge level is decreasing. Stop work as soon as possible.
- 1 level monitoring LED is lit: Battery is flat. Stop work IMMEDIATELY and charge the battery. Otherwise the battery's service life will be greatly shortened.

	
Lights	Light Indicators
	Charge level button
	The battery is at 30% capacity and requires charging
	The battery is at 60% capacity and requires charging soon
	The battery is at full capacity

NOTE: If the charge level button does not appear to be working, place the battery pack on the charger and charge as needed.

Immediately after using the battery pack, the charge level button may display a lower charge than it will if checked a few minutes later. The battery cells "recover" some of their charge after resting.

Charger Operation

⚠WARNING! Charge only iON+ 24V lithium-ion battery packs with its compatible iON+ 24V lithium-ion quick charger. Other types of batteries may cause personal injury and damage. To reduce the risk of electric shock, do not allow water to flow into the charger's AC/DC plug.

TOOL ONLY
BATTERY + CHARGER SOLD SEPARATELY

In order to operate this cordless high volume inflator you will need an iON+ 24V System battery and charger. See page 14 for battery and charger options and specifications, or for more information visit sunjoe.com.

When to Charge the iON+ 24V Lithium-iON Battery

NOTE: The iON+ 24V lithium-ion battery packs do not develop a "memory" when charged after only a partial discharge. Therefore, it is not necessary to run down the battery pack before inserting the charger plug.

- Use the battery charge indicator lights to determine when to charge your iON+ 24V lithium-ion battery pack.
- You can "top-off" your battery pack's charge before starting a big job or after a long day of use.

Charging the Battery

1. Push the push lock button on the battery to pull it out of the equipment (Fig. 1).

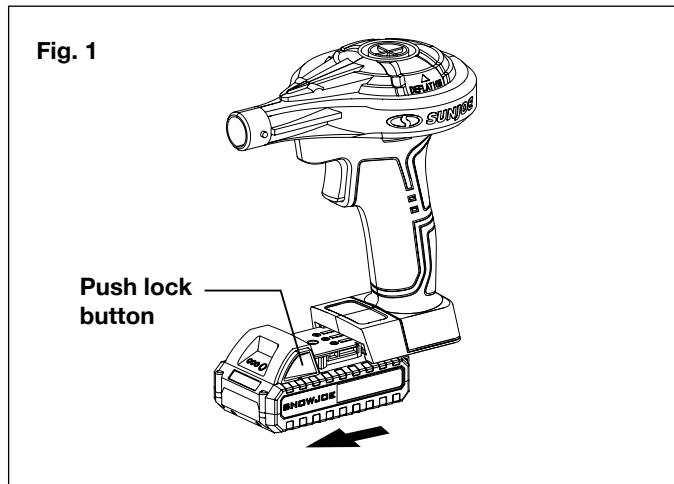

2. Depending on your Snow Joe® + Sun Joe® charger model, how to recharge your lithium-ion battery will vary. You may either insert your 24-volt battery into the 24VCHRG-QC Quick Charger (sold separately) or the 24VCHRG-DPC Dual Port Charger (sold separately) (Figs. 2 – 3).

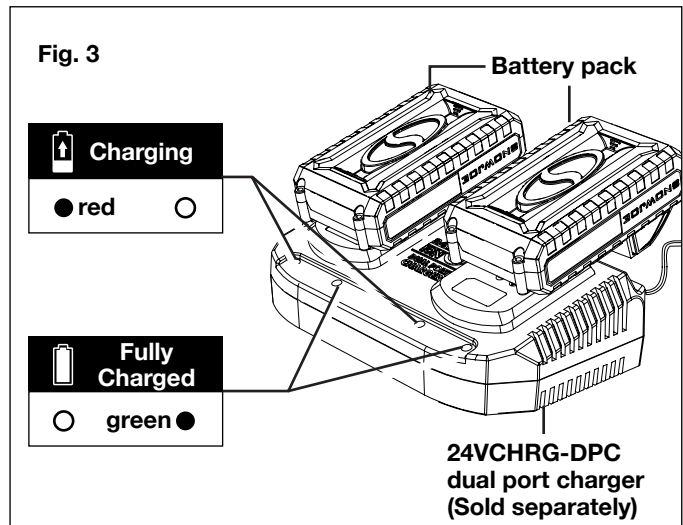
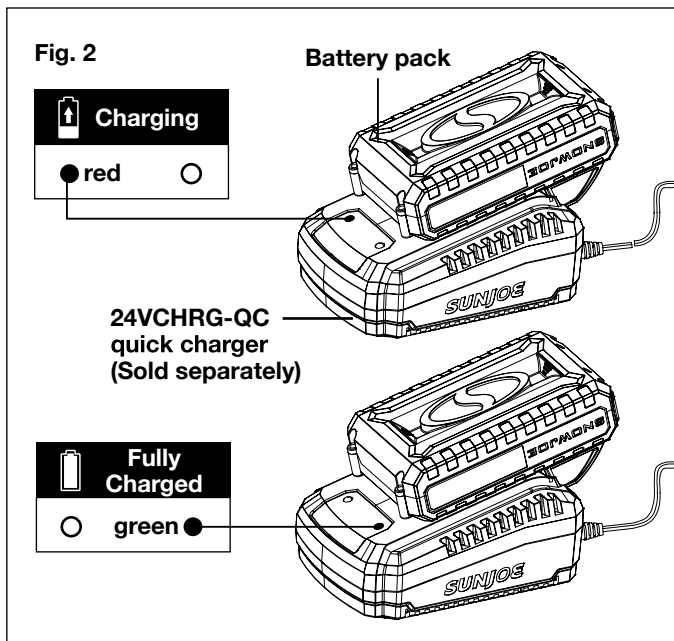

3. The battery indicator LEDs will illuminate one by one during the charging process. Unplug the charger immediately when the 3 LEDs are all illuminated.
4. The 24VCHRG-QC Quick Charger (sold separately) and the 24VCHRG-DPC Dual Port Charger (sold separately) are also equipped with additional charging indicating lights which will indicate the charging status (Figs. 2 – 3).

⚠ CAUTION! FIRE HAZARD. When disconnecting the charger from the battery, be sure to unplug the charger from the outlet first, then disconnect the charger from the battery.

⚠ WARNING! This charger does not automatically turn off when the battery is fully charged. Please take care not to leave the battery plugged into the charger. Switch off or unplug the charger at the mains when charging is complete.

5. Timely recharging of the battery will help prolong the battery's life. You must recharge the battery pack when you notice a drop in the equipment's power.

IMPORTANT! Never allow the battery pack to become fully discharged as this will cause irreversible damage to the battery.

6. When charging is complete, remove the battery from the charger by pulling the push lock button and sliding the battery backward to unlock it from the charger.

Assembly

This high volume inflator requires no assembly in order to be used. Any of the three adapters may be used for specific tasks.

Attaching the Adapters

This high volume inflator is equipped with three inflator adapters. It is recommended to leave them connected, as disconnecting the adapters may make them easier to lose.

1. To attach an adapter to the inflator end, align the notches on the high volume inflator nozzle with the slots on the adapter of your choice and slide together. Twist the adapter to lock into place (Fig. 4).

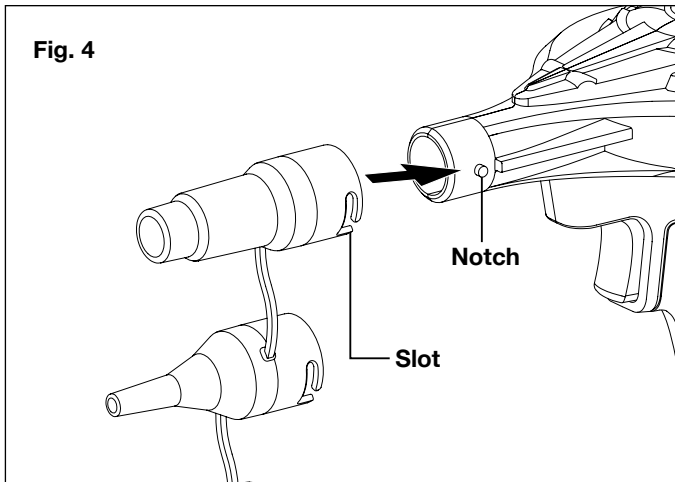

Fig. 4

2. To attach an adapter to the deflator end, simply snap the adapter into place (Fig. 5).

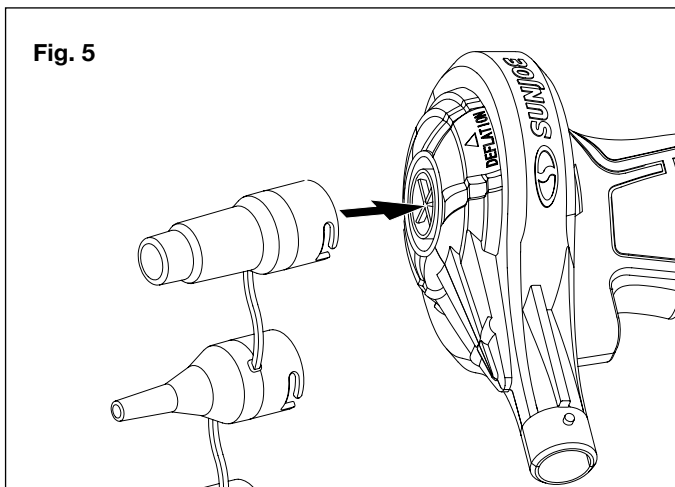

Fig. 5

Operation

TOOL ONLY BATTERY + CHARGER SOLD SEPARATELY

In order to operate this cordless high volume inflator you will need an iON+ 24V System battery and charger. See page 14 for battery and charger options and specifications, or for more information visit sunjoe.com.

⚠ WARNING! Do not use any attachments or accessories not recommended by the manufacturer of this high volume inflator. The use of attachments or accessories not recommended can result in serious personal injury.

⚠ WARNING! The high volume inflator is capable of inflating to 0.7 PSI, 0.05 BAR. To avoid over inflation, carefully follow instructions on items to be inflated. Never exceed recommended pressures.

⚠ CAUTION! Do not leave items to be inflated unattended while high volume inflator is in use. These items can burst and could cause serious injury.

Adapter Functions (Fig. 6)

- The small adapter (0.17 in) can be used on smaller air valves to inflate items like beach balls, children's toys, and pool inflatables. The adapter can be used to deflate vacuum compression bags.
- The medium adapter (0.19 in) is ideal for inflating and deflating air mattresses, inflatable pools, and rafts.
- The large adapter (0.5 in) is ideal for high-volume inflatables like bounce houses and boats.

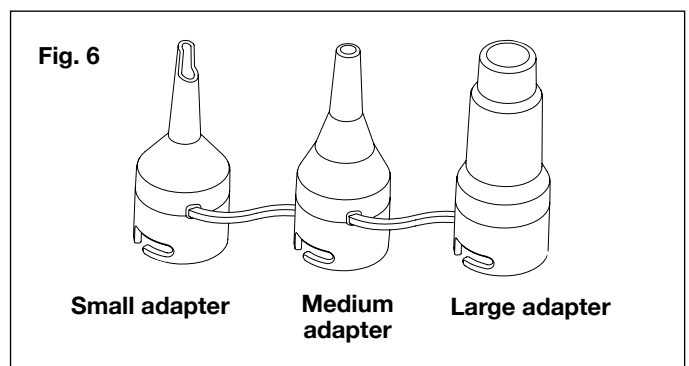

Fig. 6

Starting + Stopping

1. Slide the battery into the battery compartment until it clicks to lock it into position (Fig. 7).

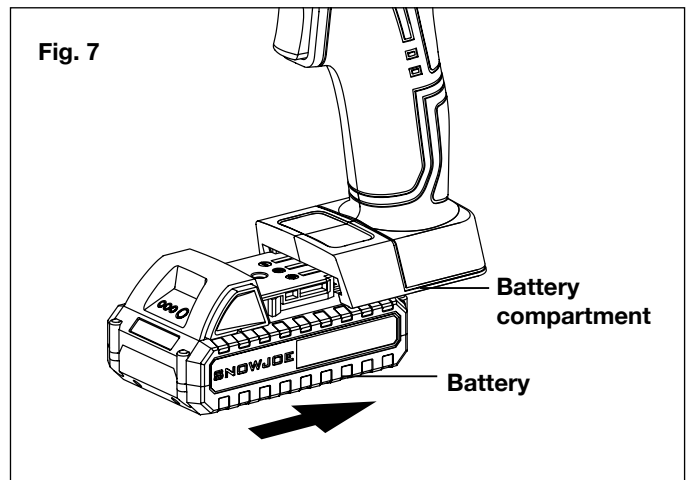
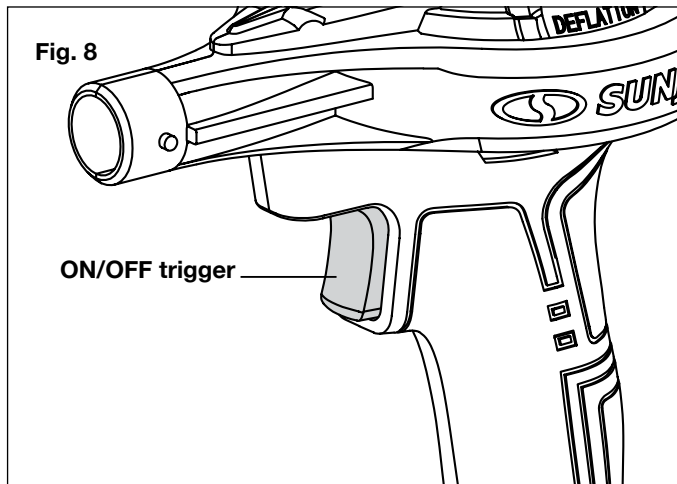

Fig. 7

2. Select and assemble the appropriate adapter for the job. Insert the nozzle of the adapter into the air port on the object you wish to inflate and deflate (Fig. 4).
3. To turn the high volume inflator ON, press the ON/OFF trigger once. To stop, press the ON/OFF button once more (Fig. 8).



4. When the item is fully inflated or deflated, turn the unit off, remove it from the air port, and close the port.

NOTE: Since most high volume inflatable's require very low pressure, this inflator does not have an air pressure gauge, it is designed to inflate to the correct "feel".

Storage

1. Examine the cordless high volume inflator thoroughly for worn, loose, or damaged parts. Should you need to repair or replace a part, contact an authorized Snow Joe® + Sun Joe® dealer or call the Snow Joe® + Sun Joe® customer service center at 1-866-SNOWJOE (1-866-766-9563) for assistance.
2. Remove the battery from the cordless high volume inflator before storing.
3. Store the high volume inflator in a dry, well-ventilated place that is inaccessible to children. Keep away from corrosive agents.

Cleaning And Maintenance

⚠️WARNING! Do not at any time let brake fluids, gasoline, petroleum based products, penetrating oils, etc., come in contact with plastic parts. Chemicals can damage, weaken or destroy plastic which can result in serious personal injury.

Cleaning

- Keep the ventilation slots of the machine clean to prevent overheating of the engine.
- Regularly clean the machine housing with a soft cloth, preferably after each use. Keep the ventilation slots free from dust and dirt.
- If the dirt does not come off use a soft cloth moistened with soapy water.
- Never use solvents such as petrol, alcohol, ammonia water, etc. These solvents may damage the plastic parts.

Maintenance

Our machines have been designed to operate over a long period of time with a minimum of maintenance. Continuous satisfactory operation depends upon proper machine care and regular cleaning.

NOTE: Snow Joe® + Sun Joe® will not be held responsible for any damage or injuries caused by repair of the high volume inflator by an unauthorized person or by mishandling of the high volume inflator.

Spare parts may be ordered online at sunjoe.com or via phone by contacting the Snow Joe® + Sun Joe® customer service center at 1-866-SNOWJOE (1-866-766-9563).

Avoid using solvents when cleaning plastic parts. Most plastics are susceptible to damage from various types of commercial solvents and may be damaged by their use. Use clean cloths to remove dirt, dust, oil, grease, etc.

Disposal

Should your appliance need replacement after extended use, do not dispose of it with the household refuse, but in an environmentally safe way.



Waste produced by electrical machine items should not be handled like normal household rubbish. Please recycle where recycle facilities exist. Check with your local authority or retailer for recycling advice.

Troubleshooting

- If the high volume inflator does not function, check the battery and make sure it is charged.
- If the battery does not charge, check the charger adapter and the charger adapter cable are connected correctly. Remove the battery pack and allow it to cool down to room temperature.
- If there is no pressure, check the adapter and make sure it is well fitted.
- If the inflator operated but article does not inflate, make sure you are using the correct adapter. Clean the adapter and check if the adapter is well fitted.

Battery Caution + Disposal

Always dispose of your battery pack according to federal, state, and local regulations. Contact a recycling agency in your area for recycling locations.

⚠️CAUTION! Even discharged battery packs contain some energy. Before disposing, use electrical tape to cover the terminals to prevent the battery pack from shorting, which could cause a fire or explosion.

⚠️WARNING! To reduce the risk of injury or explosion, never burn or incinerate a battery pack even if it is damaged, dead, or completely discharged. When burned, toxic fumes and materials are emitted into the surrounding atmosphere.

1. Batteries vary according to device. Consult your manual for specific information.
2. Install only new batteries of the same type in your product (where applicable).
3. Failure to insert batteries in the correct polarity, as indicated in the battery compartment or manual, may shorten the life of the batteries or cause batteries to leak.
4. Do not mix old and new batteries.
5. Do not mix Alkaline, Standard (Carbon-Zinc), or Rechargeable (Nickel Cadmium, Nickel Metal Hydride, or Lithium-Ion) batteries.
6. Do not dispose of batteries in fire. The cell of the battery may explode.
7. Batteries should be recycled or disposed of as per state and local guidelines.

Service + Support

- High volume inflator service must be performed only by qualified repair personnel. Service or maintenance performed by unqualified personnel may result in a risk of injury.
- When servicing an high volume inflator, use only identical replacement parts. Follow instructions in the cleaning and maintenance section of this manual. Use of unauthorized parts or failure to follow maintenance instructions may create a risk of shock or injury.
- If your Sun Joe® cordless high volume inflator requires service or maintenance, please call the Snow Joe® + Sun Joe® customer service center at 1-866-SNOWJOE (1-866-766-9563).



Model + Serial Numbers

When contacting the company or reordering parts, you will need to provide the model and serial numbers of your product. These are found on the decal affixed to the housing or handle of your cordless compressor. Copy these numbers into the space provided below.

Record the following numbers from the housing or handle of your new product:	
Model #:	<div style="border: 1px solid black; display: flex; justify-content: space-between; padding: 2px;"> 2 4 V - A J V - C T - R M </div>
Serial #:	<div style="border: 1px solid black; display: flex; justify-content: space-between; padding: 2px;"> </div>

Optional Accessories

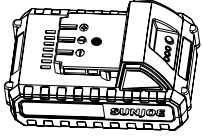
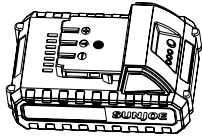
⚠ WARNING! ALWAYS use only authorized Snow Joe® + Sun Joe® replacement parts and accessories. NEVER use replacement parts or accessories that are not intended for use with this cordless high volume inflator. Contact Snow Joe® + Sun Joe® if you are unsure whether it is safe to use a particular replacement part or accessory with your cordless high volume inflator. The use of any other attachment or accessory can be dangerous and could cause injury or mechanical damage.

Accessories	Item	Model
<p>①</p> 	iON+ 24V 1.3 Ah Lithium-Ion Battery	24VBAT-LTW
<p>②</p> 	iON+ 24V 2.0 Ah Lithium-Ion Battery	24VBAT-LTE
<p>③</p> 	iON+ 24V 4.0 Ah Lithium-Ion Battery	24VBAT
<p>④</p> 	iON+ 24V Lithium-Ion Battery Quick Charger	24VCHRG-QC

NOTE: Accessories are subject to change without any obligation on the part of Snow Joe® + Sun Joe® to provide notice of such changes. Accessories can be ordered online at sunjoe.com or via phone by contacting the Snow Joe® + Sun Joe® customer service center at 1-866-SNOWJOE (1-866-766-9563).



SNOW JOE® + SUN JOE® REFURBISHED GOODS WARRANTY

GENERAL CONDITIONS:

Snow Joe® + Sun Joe® operating under Snow Joe®, LLC warrants this refurbished product to the original purchaser for 90 days against defects in material or workmanship when used for normal residential purposes. If a replacement part or product is needed, it will be sent free of charge to the original purchaser except as noted below.

The duration of this warranty applies only if the product is put to personal use around the household. It is the owner's responsibility to correctly perform all maintenance and minor adjustments explained in the owner's manual.

HOW TO OBTAIN YOUR REPLACEMENT PART OR PRODUCT:

To obtain a replacement part or product, please visit snowjoe.com/help or email us at help@snowjoe.com for instructions. Please be sure to register your unit beforehand to speed up this process. Certain products may require a serial number, typically found on the decal affixed to the housing or guard of your product. All products require a valid proof of purchase.

EXCLUSIONS:

- Wearing parts like belts, augers, chains and tines are not covered under this warranty. Wearing parts can be purchased at snowjoe.com or by calling 1-866-SNOWJOE (1-866-766-9563).
- Batteries are covered in full for 90-days from the date of purchase.

Snow Joe® + Sun Joe® may from time to time change the design of its products. Nothing contained in this warranty shall be construed as obligating Snow Joe® + Sun Joe® to incorporate such design changes into previously manufactured products, nor shall such changes be construed as an admission that previous designs were defective.

This warranty is intended to cover product defects only. Snow Joe®, LLC is not liable for indirect, incidental or consequential damages in connection with the use or misuse of the Snow Joe® + Sun Joe® products covered by this warranty. This warranty does not cover any cost or expense incurred by the purchaser in providing substitute equipment or service during reasonable periods of malfunction or non-use of this product while waiting for a replacement part or unit under this warranty. Some states do not allow exclusions of incidental or consequential damages so the above exclusions may not apply in all states. This warranty may give you specific legal rights in your state.

HOW TO REACH US:

We're here to help Monday through Friday from 9AM to 7PM EST and Saturday and Sunday 9AM to 4PM. You can reach us at 1-866-SNOWJOE (1 866-766-9563), online at snowjoe.com, via email at help@snowjoe.com or tweet us @snowjoe.

EXPORTS:

Customers who have purchased Snow Joe® + Sun Joe® products exported from the United States and Canada should contact their Snow Joe® + Sun Joe® distributor (dealer) to obtain information applicable to your country, province or state. If for any reason, you are not satisfied with the distributor's service, or if you have difficulty obtaining warranty information, contact your Snow Joe® + Sun Joe® seller. If in the event your efforts are unsatisfactory, please reach out to us directly.



sunjoe.com