



OPERATOR'S MANUAL

A Division of Snow Joe®, LLC

CORDLESS PRUNER

3.6V MAX* | 2.0 Ah | RECHARGEABLE

Model PJ3600C-RM

Form No. SJ-PJ3600C-RM-880E-MR6-V2

THANKS FOR YOUR PURCHASE OF A REMANUFACTURED PRODUCT.

To make sure you get the most out of your product, be sure to register online at

sunjoe.com

to enjoy full product support.

PASTE UPC LABEL HERE



OPERATOR'S MANUAL

A Division of Snow Joe®, LLC

CORDLESS PRUNER

3.6V MAX* | 2.0 Ah | RECHARGEABLE

Model PJ3600C-RM

Form No. SJ-PJ3600C-RM-880E-MR6-V2

IMPORTANT!

Safety Instructions

All Operators Must Read These Instructions Before Use

Always follow these safety guidelines. Failure to do so may result in serious bodily injury or death.

General Safety WARNINGS!

Notice the personal safety alert symbol  used in this manual to draw your attention to a WARNING given along with the particular operating instruction. This means that the operation requires special **ATTENTION**, **CAUTION**, and **AWARENESS**.

When using this power tool, basic safety precautions, including the following, should always be followed to reduce the risk of fire, electric shock, personal injury and material damage.

⚠️WARNING! This unit can be dangerous! Careless or improper use can cause serious injury.

⚠️WARNING! The cutting blades can cut you. Keep hands and feet away from the blades and the cutting area.

Retain this manual for future reference and reread it at the start of each trimming season.

⚠️WARNING! This battery-operated power tool must be recharged only with the specific charging unit for the battery. A charging unit that may be suitable for one type of battery may create a risk of fire when used with another battery type.

- Avoid accidental starting.
- When the tool is not in use, keep it away from other metal objects.
- Before operating the tool, read the entire manual carefully and make sure you know how to switch the tool OFF in an emergency.

Work Area Safety

1. **Keep work area clean and well lit.** Cluttered and dark areas invite accidents.
2. **Do not operate power tools in explosive atmospheres, such as in the presence of flammable liquids, gases**

or dust. Power tools create sparks which may ignite the dust or fumes.

3. **Keep bystanders and children away.** All bystanders, including children and pets, should be kept a safe distance away from the work area.
4. **Avoid dangerous environment.** Don't use the appliance in wet or damp location.

Electrical Safety

1. If the battery charger cable is damaged, please call the Snow Joe® + Sun Joe® customer service center at 1-866-SNOWJOE (1-866-766-9563).
2. If charging the power tool in a damp location is unavoidable, use a residual current device (RCD) protected power supply. The using of an RCD reduces the risk of electric shock.
3. **Power tool plugs must match the outlet. Never modify the plug in any way.** Do not use any earthed (grounded) power tools or battery chargers. Unmodified plugs and matching outlets will reduce risk of electric shock.
4. **Avoid body contact with earthed or grounded surfaces such as pipes, radiators, ranges and refrigerators.** There is an increased risk of electric shock if your body is earthed or grounded.
5. **Do not expose power tools to rain or wet conditions.** Water entering a power tool will increase the risk of electric shock.
6. **Do not abuse the charging cord.** Never use the cord for carrying, pulling or unplugging the power tool. Keep cord away from heat, oil, sharp edges or moving parts. Damaged or entangled cords increase the risk of electric shock.
7. Battery charger is for indoor use only. Only charge this battery-powered tool indoors.

Personal Safety

1. **Stay alert. Watch what you are doing and use common sense when operating a power tool.** Do not use the power tool while you are tired or under the influence of drugs, alcohol or medication. A moment of inattention while operating power tool may result in serious personal injury.
2. **Use personal protective equipment. Always wear eye protection.** Protective equipment such as safety glasses, a dusk mask, non-skid safety shoes, a hard hat, and hearing protection, when used for appropriate conditions, will reduce the possibility of personal injuries.

3. **Avoid unintentional starting.** Ensure the switch is in the OFF position before connecting to the power source/ battery charger, or before picking up or carrying the tool. Carrying power tools with your finger on the switch or charging power tools with the switch ON can lead to accidents.
4. **Do not overreach.** Keep proper footing and balance at all times. This enables better control of the power tool in unexpected situations.
5. **Dress properly.** Do not wear loose clothing or jewelry. Dangling articles such as these can become caught in moving parts. Using work gloves and substantial footwear is recommended when working outdoors. Wear a protective hair covering to contain long hair.
6. **If devices are provided for the connection of dust extraction and collection facilities, ensure these are connected and properly used.** Use of these devices can reduce dust related hazards.

Power Tool Use and Care

1. **Do not force the appliance.** It will do the job better with less likelihood of injury if it is used at the rate for which it was designed.
2. **Use the right appliance.** Do not use the appliance for any job except that for which it is intended.
3. **Do not use the power tool if the switch does not turn it on and off.** Any power tool that cannot be controlled by the switch is dangerous and must be repaired.
4. **Disconnect the battery pack from the power tool before making any adjustments, changing accessories or storing the power tool.** Such preventative safety measures reduce the risk of starting the power tool accidentally.
5. **Store idle appliances indoors.** When not in use, appliances should be stored indoors in a dry and high or locked-up place out of the reach of children.
6. **Maintain appliance with care.** Check for misalignment or binding of moving parts, breakage of parts and any other condition that may affect the power tool's operation. If damaged, have the power tool repaired before use. Many accidents are caused by poorly maintained power tools.
7. **Keep cutting blades sharp and clean.** Properly maintained cutting blades with sharp edges are less likely to bind and are easier to control.
8. **Use the power tool and accessories in accordance with these instructions and in the manner intended for the particular use of the power tool, taking into account the working conditions and the work to be performed.** Using the power tool for operations different from those intended could result in a hazardous situation.
9. **Keep all parts of the body away from the cutting blade.** Do not remove cut material or hold material to be cut when blades are moving. Make sure the switch is off when clearing jammed material. A moment of inattention while operating the product may result in serious personal injury.

10. **Carry the product by the handle with the cutting blade stopped.** When transporting or storing the product always fit the cutting device cover. Proper handling of the product will reduce possible personal injury from the cutter blades.

Service

1. **If your power tool requires service, contact an authorized Snow Joe® + Sun Joe® dealer or call the Snow Joe® + Sun Joe® customer service center at 1-866-SNOWJOE (1-866-766-9563).** Only identical replacement parts should be utilized for repairs. This will ensure that the safety of the power tool is maintained.
2. **If the battery charger cable is damaged, it must be immediately replaced to avoid a hazard.** Contact the Snow Joe® + Sun Joe® customer service center at 1-866-SNOWJOE (1-866-766-9563) for assistance.

Battery Safety Warnings

This manual contains important safety and operating instructions for your battery and charger.

1. **Before using, always check the charger, cable and plug. If defects are detected, do not use the charger; never open the charger.** Thoroughly read all instructions and cautionary markings on the manual, the charger, and the cordless pruner.











⚠WARNING! If the cordless pruner housing is cracked or damaged, do not insert the charging adapter into the power tool or plug the power tool into the mains outlet. There is a danger of electric shock or electrocution.

2. **Protect the battery charger from rain and moisture.** Water penetration in a battery charger increases the risk of electric shock.
3. **Only use the included battery for this unit.**
4. **Do not open or modify the battery.** Release electrolyte is corrosive and may cause damage to eyes and skin. It may be toxic if swallowed.
5. **Keep the battery charger clean.** Contamination may increase the risk of electric shock.
6. **Do not short circuit.** A battery pack will short circuit if a metal object makes a connection between the positive and negative contacts on the battery pack. Do not place a battery pack near anything that may cause a short circuit, such as paper clips, coins, keys, screws, nails and other metallic objects. A short-circuited battery pack poses a risk of fire and severe personal injury.
7. This charger is **ONLY** intended to charge the rechargeable battery inside of the cordless pruner. Any other use poses a risk of fire, electric shock or electrocution.
8. Do not place any object on top of the charger or place the charger on a soft surface that may result in excessive internal heat. Keep the charger away from any heat source.
9. To reduce the risk of damaging the electric plug and cord, pull the plug, not the cord, when disconnecting the charger from the electric outlet.

10. Make sure the battery charging cable is located in a safe place so that it will not be stepped on, tripped over or otherwise subjected to damage or stress.
11. An extension cord should not be used unless absolutely necessary. Using an improper extension cord poses a risk of fire, electric shock or electrocution.
12. Do not operate the charger if it has received a sharp blow or has become damaged in any way. Contact the Snow Joe® + Sun Joe® customer service center at 1-866-SNOWJOE (1-866-766-9563) before continuing use.
13. Do not disassemble the charger. Incorrect reassembly may pose a serious risk of electric shock, fire or exposure to toxic battery chemicals. If the battery or charger are damaged, contact an authorized Snow Joe® + Sun Joe® dealer or call the Snow Joe® + Sun Joe® customer service center at 1-866-SNOWJOE (1-866-766-9563) for assistance.
14. To reduce the risk of electric shock, unplug the charger from the outlet before cleaning the unit.
15. Never attempt to connect two (2) chargers together.
16. DO NOT store or use the tool and the charger in locations where the temperature may reach or exceed 104 °F (40 °C). Dangerous storing locations include outdoor sheds or metal buildings in the summer.
17. The charger is designed to operate on standard household electrical power (120V). Do not attempt to use it with any other voltage!
NOTE: The integrated battery is not fully charged out of the carton. Read the safety instructions and then follow the charging notes and procedures.
18. The longest life and best performance can be obtained if the integrated battery is charged when the air temperature is between 64.4 °F – 75.2 °F (18 °C – 24 °C). Do not charge the battery pack when the air temperature falls below 50 °F (10 °C) or above 104 °F (40 °C). Following these safety measures will prevent damage to the battery pack.
19. Do not incinerate the integrated battery even if it is seriously damaged or completely worn out. The battery can explode in a fire.

Safety Symbols

The following table depicts and describes safety symbols that may appear on this product. Read, understand and follow all instructions on this tool before attempting to assemble and operate.

Symbols	Descriptions	Symbols	Descriptions
	READ THE OPERATOR'S MANUAL(S) – Read, understand and follow all instructions in the user manual(s) before attempting to assemble and operate.		SAFETY ALERT – Indicates a precaution, a warning or a danger.
	WARNING! Do not expose the unit to rain or wet conditions. Keep dry.		Battery charger contains a safety transformer.
	Wear protective gloves and non-slip footwear when using the machine and handling debris.		DANGER! Keep hands away from blade.
	Only use battery charger indoors.		Risk of Injury. Use safety glasses, hearing protection and dust mask.
	Thrown objects and moving blade can cause severe injury.		Keep bystanders a safe distance away from the work area.

Know Your Cordless Pruner

Read the owner's manual and safety instructions carefully before operating cordless pruner. Compare the illustration below to the cordless pruner in order to familiarize yourself with the location of the various controls and adjustments. Save this manual for future reference.

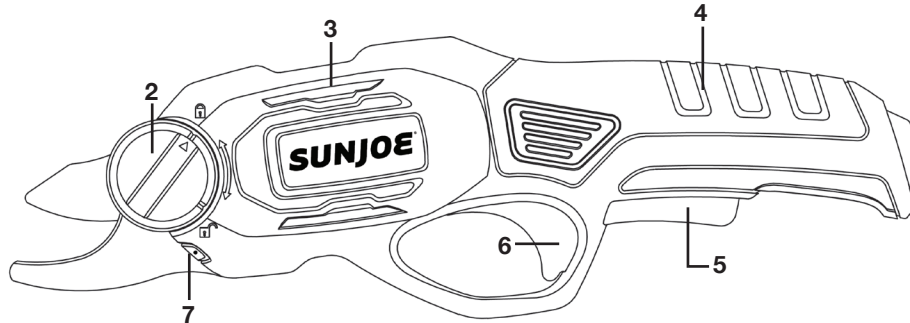

The other side

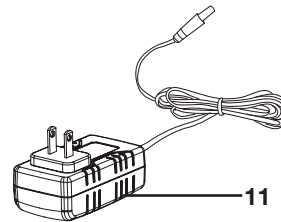
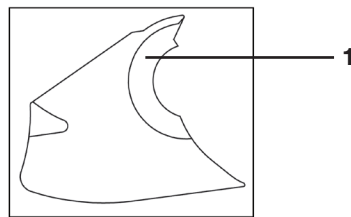
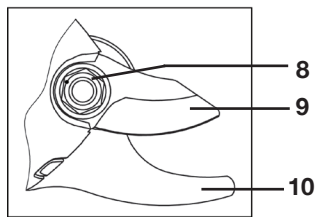

End of the handle

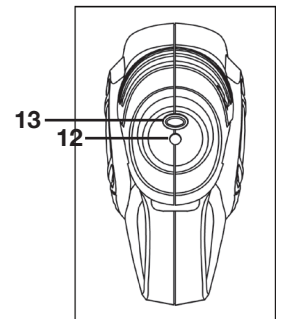

- | | |
|-----------------------|------------------------|
| 1. Blade cover | 8. Blade lock bolt |
| 2. Blade lock knob | 9. Removable blade |
| 3. Machine housing | 10. Fixed blade |
| 4. Handle | 11. AC charger |
| 5. Safety lock button | 12. Charging socket |
| 6. On/Off switch | 13. Charging indicator |
| 7. LED light (2) | |

Technical Data

Motor	40 W	Cutting Diameter Max	0.5 in. (12.7 mm)
Battery Voltage Max*	3.6V D.C.	Cutting Speed	≤ 0.6 s
Battery Capacity	2.0 Ah	Cutting Times Max	750 cuts per charge (based on 9 mm soft wood cuts)
Battery Type	Lithium-ion	Net Weight	1.4 lbs (0.65 kg)
Charger Input	120V ~ 60 Hz 13 W		
Charger Output	5.4V = 1.8A		
Charging Time Max	65 min		

*Initial no-load voltage, when fully charged, peaks at 4.2 volts; nominal voltage under typical load is 3.6 volts.

Unpacking

Carton Contents

- Cordless pruner
- Blade cover
- Charger
- Manual with registration card

1. Carefully remove the cordless pruner and check to see that all of the above items are supplied.
2. Inspect the product carefully to make sure no breakage or damage occurred during shipping. If you find damaged or missing parts, DO NOT return the unit to the store. Please call the Snow Joe® + Sun Joe® customer service center at 1-866-SNOWJOE (1-866-766-9563).

NOTE: Do not discard the shipping carton and packaging material until you are ready to use your new cordless pruner. The packaging is made of recyclable materials. Properly dispose of these materials in accordance with local regulations.

IMPORTANT! The equipment and packaging material are not toys. Do not let children play with plastic bags, foils or small parts. These items can be swallowed and pose a suffocation risk!

Assembly

This cordless pruner comes completely assembled with the blade pre-installed.

CAUTION! Wear protective gloves before handling the blade.

WARNING! Make sure the unit is powered off before handling the blade.

Fitting and Changing the Blade

WARNING! Use only recommended replacement blade.

NOTE: Cutting will become difficult when the blade edge has become dull, at which time you should change the blade.

WARNING! Make sure that the pruner is off and always wear protective gloves while changing the blade.

WARNING! Risk of injury; keep hands away from the switches when changing the blade.

1. Rotate the blade lock knob clockwise to unlock (Fig. 1).

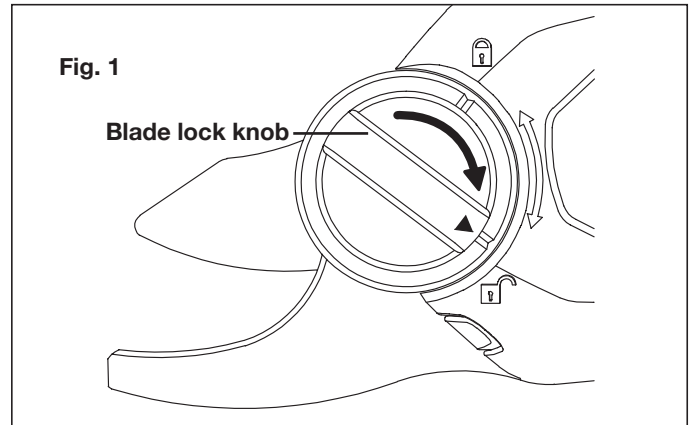

2. Wearing gloves, grasp the removable blade and pull it from the pruner to remove it (Fig. 2).

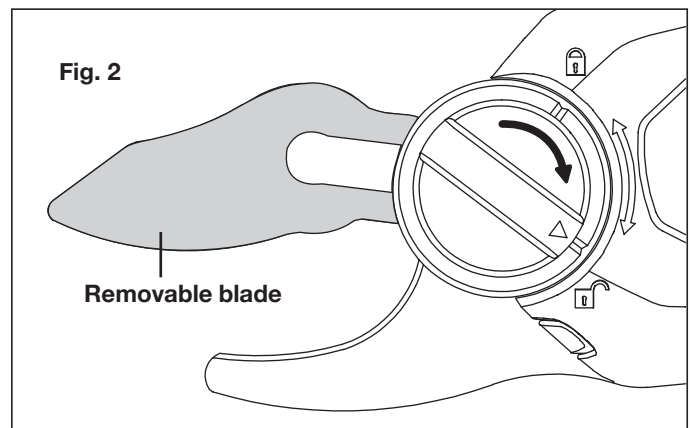

3. Insert the new blade into position, and listen for the audible "click" that indicates that the blade is fixed in place.
4. Lock the blade lock knob by turning it counter-clockwise, and listen for the audible "click" that indicates the knob is locked in position (Fig. 3).

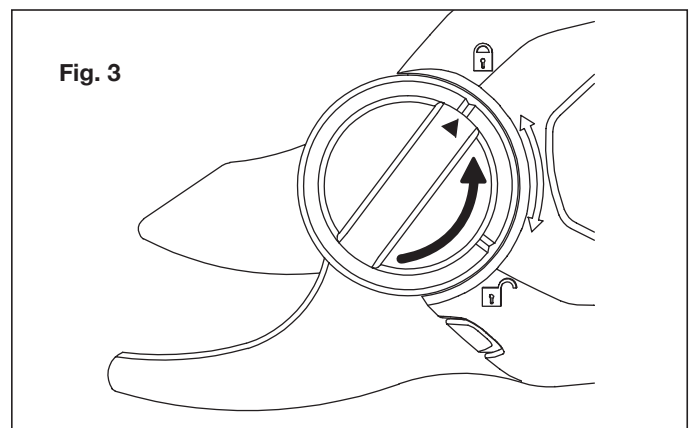

Before Using

Charging Procedure

The battery charger supplied matches the lithium-ion battery installed in the tool. Do not use other battery chargers.

The lithium-ion battery is protected against deep discharging. When the battery is empty, a protective circuit will automatically switch OFF the machine. The blade will no longer move.

Charge the battery up to 65 minutes then use it until it runs down (i.e. the tool starts to operate slowly). Recharge for up to 65 minutes again before resuming operation.

⚠WARNING! Continued and excessive overuse of the ON/OFF trigger switch can permanently damage the lithium-ion battery.

⚠CAUTION! This charger does not automatically turn off when the battery is fully charged. Please take care not to leave the pruner plugged into the charger. Switch off or unplug the charger at the mains when charging is complete.

NOTE: The charge level indicator LED light will illuminate red when the charger is plugged in and is charging the cordless pruner. The LED light will turn green when the pruner is fully charged.

The charging process starts as soon as the charger is plugged into both the proper electrical outlet and the tool.

- During the charging procedure, the handle and the housing of the tool will feel slightly warm to the touch. This is normal.
- When no further use is planned for an extended period of time, disconnect the battery charger from the outlet and the unit.
- Do not use the tool during the charging procedure.

Battery Charging

The length of service between each charging varies depending on the type of work you are doing. The battery in this pruner has been designed to provide maximum trouble-free life. However, like all batteries, it will eventually wear out. To obtain the longest possible battery life, we suggest the following:

- Store and charge your cordless pruner in a cool area. Temperatures above or below normal room temperature will shorten battery life.
- Never store the cordless pruner with the battery in a discharged condition. Recharge the unit immediately after it is discharged.
- All batteries gradually lose their charge. The higher the temperature is, the faster they lose their charge. If you store your cordless pruner for long periods of time without using it, recharge the battery every 6 months. This will extend battery life.

NOTE: The cordless pruner has been shipped in a low charge condition and should be fully charged before use.

1. Plug the charger adapter into an appropriate AC power outlet. Connect the AC adapter charger plug into the charging socket of the cordless pruner to start charging (Fig. 4).

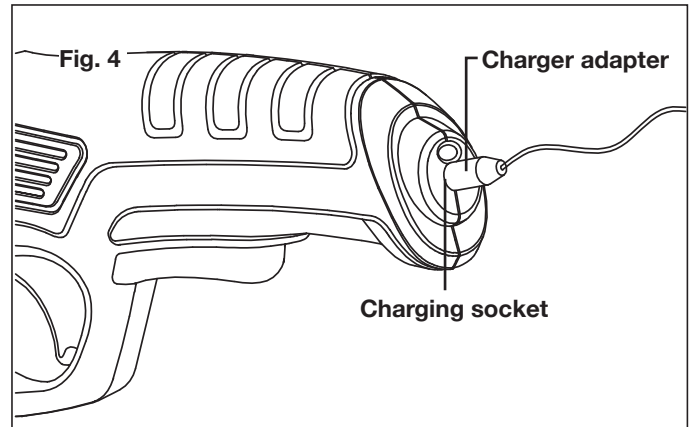

2. The LED charging indicator will illuminate red during charging. After the unit is fully charged, the charging indicator will turn green (Fig. 5).

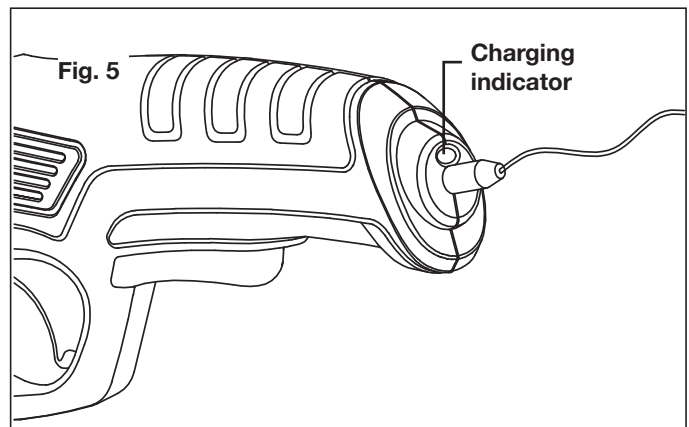

3. The battery will take approximately 65 minutes to charge. Charging time may vary due to the level of charge left in the battery and the ambient temperature.

Operation

IMPORTANT! The product is intended for light-duty pruning of shrubs and hedges for residential properties.

NOTE: Charge the battery up to 65 minutes then use it until it runs down (i.e. the tool will only slowly operate). Recharge for up to 65 minutes again before resuming operation.

⚠WARNING! The blades continue to move for a few seconds after the tool is switched OFF. Turn OFF the tool and wait until the blades come to a complete stop before adjusting or cleaning.

⚠ CAUTION! Wear protective gloves while working with the pruner. Never touch the blade or blade rail while the tool is in operation and be aware of the sharp edges even when the pruner is not in use.

Starting + Stopping

1. To power ON, push and hold the safety lock button with your fingers, while pressing the On/Off trigger switch with your index finger. Once the On/Off switch is pressed, the removable blade will move down and the two blades will close to cut (Fig. 6).

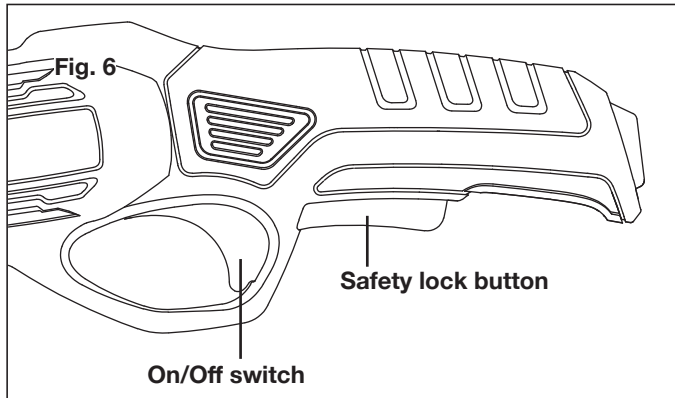

NOTE: The safety lock button reduces the risk of accidental starting.

2. Release the On/Off switch, the two blades will open (Fig. 6).

⚠ CAUTION! Always ensure proper footing and balance in a clean and clear work environment before switching on the cordless pruner.

NOTE: The pruner will stop working when the voltage is lower than 3 Volts. Please recharge as soon as possible if the pruner stops working.

LED lights

The pruner is equipped with two LED lights under the blades on both sides to provide additional lighting for operation in low light conditions. The LED lights will turn on when the safety lock button is pressed and turn off when the safety lock button is released (Fig. 7).

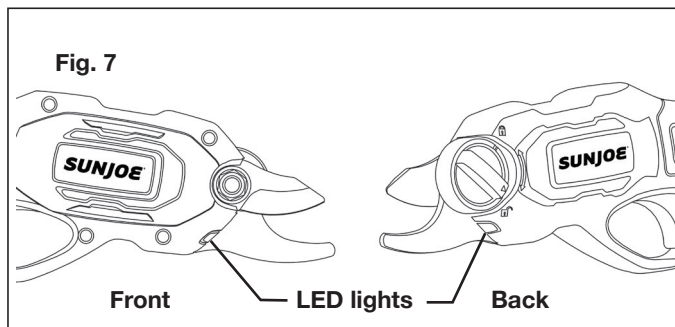

Trimming Tips

The cordless pruner can be used to remove fresh blooms from the garden; also great for pruning overgrowth, dead and overlapping stems and twigs, as well as thin and weak growth. Follow the tips below for operation.

1. Never cut too close to the bud, so the wound can heal properly.
2. Always make the cut above 0.3 inch (8 mm) from the bud (Fig. 8).

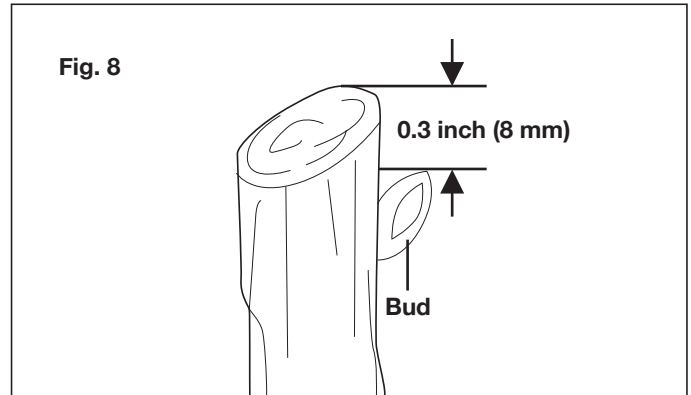

3. The cut should slope away from the bud, so the rain can run off (Fig. 9).

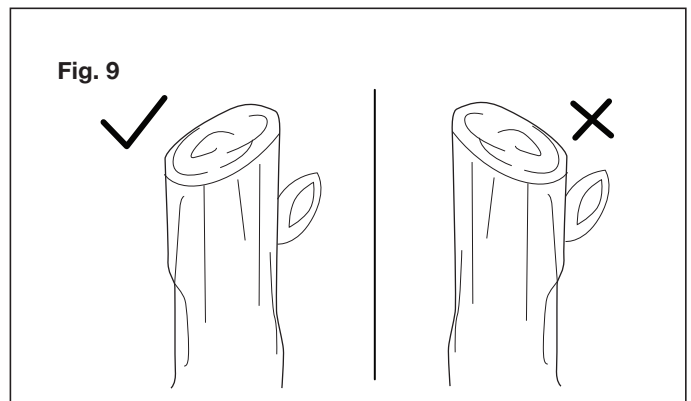

4. When removing the entire stem, cut back to the point where it branched (Fig. 10).

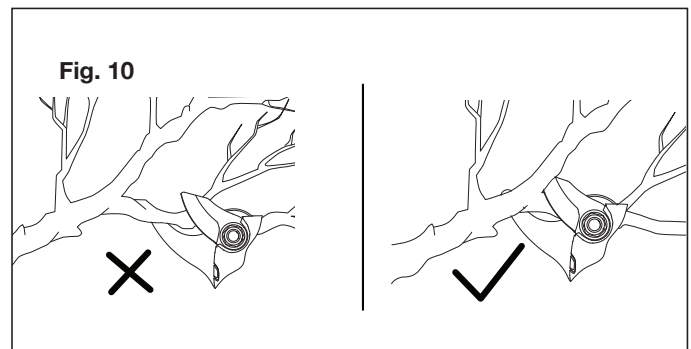

5. Cut branches one by one, as shown (Fig. 11).

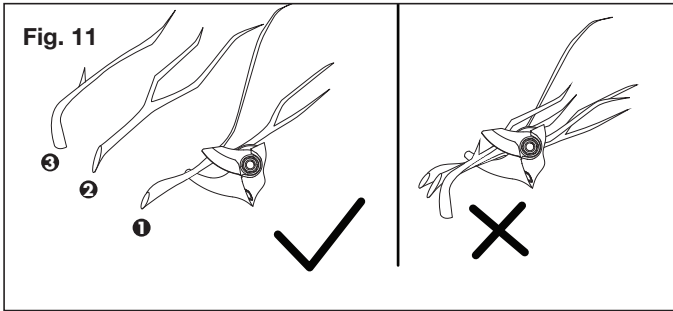

Maintenance

⚠WARNING! Always switch the product off and let the product cool down before performing inspection, maintenance, and cleaning work.

1. If the cordless pruner requires cleaning, do not use solvents to clean it. Only use a moistened soft cloth. Never let any liquid get inside the tool; and never immerse any part of the tool into any liquid.
2. Apply oil around the center bolt and open and close the tool about 10 times to work it in. Use the steel wool to rub the oil over the cutting surfaces. Spray the tool with alcohol and wipe with a paper towel.
3. Inspect the product before each use for worn and damaged parts. Do not operate it if you find broken and worn parts.

Blade Maintenance

To ensure years of efficient and trouble-free operation, blade cleaning should be performed if sap and debris have built-up, or if you live in an area where the soil is sandy. Cleaning unusually heavy deposits may require removal of the blade.

NOTE: Snow Joe® + Sun Joe® will not be held responsible for any damage or injuries caused by repair of the pruner by an unauthorized person or by mishandling of the trimmer.

1. Keep the cutting blades clean and free of debris. Remove trimmings.
2. Keep the blades sharp. Have a worn or damaged cutting device replaced with a new one of the same type by a qualified specialist. Spare parts may be ordered online at sunjoe.com or via phone by contacting the Snow Joe® + Sun Joe® customer service center at 1-866-SNOWJOE (1-866-766-9563).
3. To replace the blade, see page 7 for instructions.

Blade Sharpening

⚠WARNING! Always take extra care, especially when your hand may be facing the cutting edge.

Bypass pruners will generally only have one blade, the lower part being the counter blade which should never require sharpening.

The cut of a bypass tool is achieved by the blade precisely passing by the counter blade. It therefore follows that you should never sharpen the flat side of the blade. If steel is removed from here, the two parts will no longer meet precisely and the tool will fail to cut. You must only sharpen on the outside or bevelled side of the blade.

1. To sharpen your cordless pruner, hold the open pruner flat in one hand and with the other hand place the sharpener at a 15 degree angle along the bevelled side of the blade (Fig. 12).

NOTE: Be careful to not sharpen at too steep an angle as this could damage the edge of the blade.

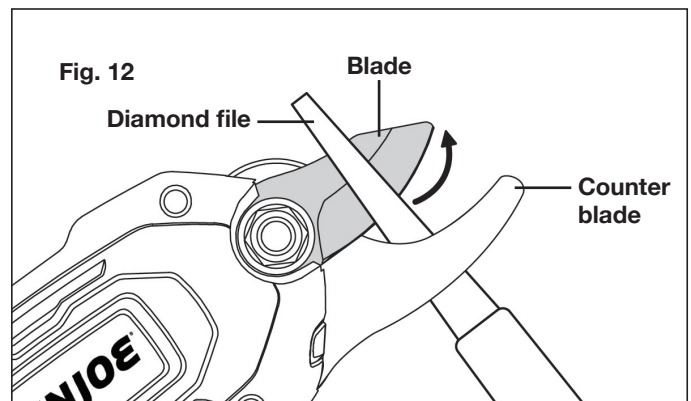

2. Move the sharpener in one direction only, with smooth strokes from base to end 4 to 5 times.

⚠WARNING! Do not over-sharpen. Be sure to test blades repeatedly throughout the sharpening process to prevent over-sharpening.

3. Turn the pruner over so the flat side of the blade is facing up and slide the sharpener flush along the unbeveled edge to remove burrs created by sharpening the cutting blade.
4. A bench vise can also be used to hold the tool during sharpening, taking care not to over tighten the vise which can bend the tool.

⚠WARNING! Minimize coating loss. Stay to the edge of the blade when sharpening blades with low-friction or titanium coating to minimize the loss of coating.

Storage

When the tool will not be used for several months, proceed as follows:

- Fully charge the battery.
- Clean the product as describe above.
- Make sure that the blade lock knob is in the lock position, then assemble the blade cover over the blades (Fig. 13).

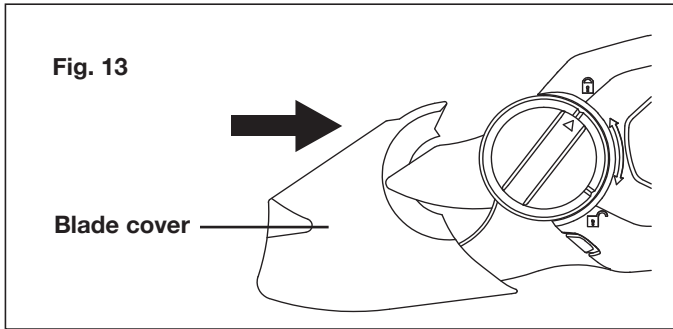

- Store the tool in a secure and dry location. The storage temperature must always remains in the range of 41°F (5°C) to 104°F (40°C).
- Before using the tool after prolonged storage, fully recharge the battery.

Battery Caution + Disposal

Always dispose of your battery pack according to federal, state, and local regulations. Contact a recycling agency in your area for recycling locations.

⚠ CAUTION! Even discharged battery packs contain some energy. Before disposing, use electrical tape to cover the terminals to prevent the battery pack from shorting, which could cause a fire or explosion.

⚠ WARNING! To reduce the risk of injury or explosion, never burn or incinerate a battery pack even if it is damaged, dead, or completely discharged. When burned, toxic fumes and materials are emitted into the surrounding atmosphere.

1. Batteries vary according to device. Consult your manual for specific information.
2. Install only new batteries of the same type in your product (where applicable).
3. Failure to insert batteries in the correct polarity, as indicated in the battery compartment or manual, may shorten the life of the batteries or cause batteries to leak.
4. Do not mix old and new batteries.
5. Do not mix Alkaline, Standard (Carbon-Zinc), or Rechargeable (Nickel Cadmium, Nickel Metal Hydride, or Lithium-Ion) batteries.

6. Do not dispose of batteries in fire. The cell of the battery may explode.
7. Batteries should be recycled or disposed of as per state and local guidelines.

Service + Support

If your Sun Joe® cordless pruner requires service or maintenance, please call the Snow Joe® + Sun Joe® customer service center at 1-866-SNOWJOE (1-866-766-9563).

Model + Serial Numbers

When contacting the company or reordering parts, you will need to provide the model and serial numbers of your product. These are found on the decal affixed to the housing or handle of your cordless pruner. Copy these numbers into the space provided below.

Record the following numbers from the housing or handle of your new product:													
												Model #:	
P	J	3	6	0	0	C	-	R	M				
												Serial #:	

PJ3600C-CHRG

Federal Communications Commission (FCC)

⚠ WARNING! Any changes or modifications to this unit not expressly approved by the party responsible for compliance could void the user's authority to operate the equipment.

Class B device:

NOTE: This equipment has been tested and found to comply with the limits for a Class B digital device, pursuant to part 15 of the FCC Rules.

These limits are designed to provide reasonable protection against harmful interference in a residential installation.

This equipment generates, uses and can radiate radio frequency energy and, if not installed and used in accordance with the instructions, may cause harmful interference to radio communications.

However, there is no guarantee that interference will not occur in a particular installation.

If this equipment does cause harmful interference to radio or television reception, which can be determined by turning the equipment off and on, the user is encouraged to try to correct the interference by one or more of the following measures:

- Reorient or relocate the receiving antenna.
- Increase the separation between the equipment and receiver.
- Connect the equipment into an outlet on a circuit different from that to which the receiver is connected.
- Consult the dealer or an experienced radio/TV technician for help.

Optional Accessories

⚠ WARNING! ALWAYS use only authorized Snow Joe® + Sun Joe® replacement parts and accessories. NEVER use replacement parts or accessories that are not intended for use with this cordless pruner. Contact Snow Joe® + Sun Joe® if you are unsure whether it is safe to use a particular replacement part or accessory with your cordless pruner. The use of any other attachment or accessory can be dangerous and could cause injury or mechanical damage.

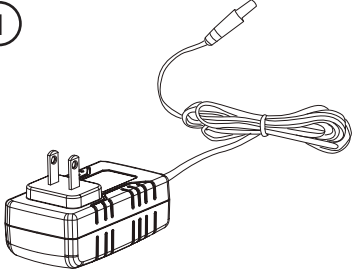
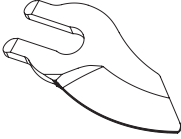
Accessories	Item	Model
<p>①</p>  A line drawing of an AC charging adapter. It consists of a rectangular base with two prongs on top and a coiled power cord with a connector at the end.	AC Charging Adapter	PJ3600C-CHRG
<p>②</p>  A line drawing of a replacement blade, which is a curved, pointed metal piece with a handle-like shape at the top.	Replacement blade	PJ3600C-BLD

NOTE: Accessories are subject to change without any obligation on the part of Snow Joe® + Sun Joe® to provide notice of such changes. Accessories can be ordered online at sunjoe.com or via phone by contacting the Snow Joe® + Sun Joe® customer service center at 1-866-SNOWJOE (1-866-766-9563).



SNOW JOE® + SUN JOE® REFURBISHED GOODS WARRANTY

GENERAL CONDITIONS:

Snow Joe® + Sun Joe® operating under Snow Joe®, LLC warrants this refurbished product to the original purchaser for 90 days against defects in material or workmanship when used for normal residential purposes. If a replacement part or product is needed, it will be sent free of charge to the original purchaser except as noted below.

The duration of this warranty applies only if the product is put to personal use around the household. It is the owner's responsibility to correctly perform all maintenance and minor adjustments explained in the owner's manual.

HOW TO OBTAIN YOUR REPLACEMENT PART OR PRODUCT:

To obtain a replacement part or product, please visit snowjoe.com/help or email us at help@snowjoe.com for instructions. Please be sure to register your unit beforehand to speed up this process. Certain products may require a serial number, typically found on the decal affixed to the housing or guard of your product. All products require a valid proof of purchase.

EXCLUSIONS:

- Wearing parts like belts, augers, chains and tines are not covered under this warranty. Wearing parts can be purchased at snowjoe.com or by calling 1-866-SNOWJOE (1-866-766-9563).
- Batteries are covered in full for 90-days from the date of purchase.

Snow Joe® + Sun Joe® may from time to time change the design of its products. Nothing contained in this warranty shall be construed as obligating Snow Joe® + Sun Joe® to incorporate such design changes into previously manufactured products, nor shall such changes be construed as an admission that previous designs were defective.

This warranty is intended to cover product defects only. Snow Joe®, LLC is not liable for indirect, incidental or consequential damages in connection with the use or misuse of the Snow Joe® + Sun Joe® products covered by this warranty. This warranty does not cover any cost or expense incurred by the purchaser in providing substitute equipment or service during reasonable periods of malfunction or non-use of this product while waiting for a replacement part or unit under this warranty. Some states do not allow exclusions of incidental or consequential damages so the above exclusions may not apply in all states. This warranty may give you specific legal rights in your state.

HOW TO REACH US:

We're here to help Monday through Friday from 9AM to 7PM EST and Saturday and Sunday 9AM to 4PM. You can reach us at 1-866-SNOWJOE (1 866-766-9563), online at snowjoe.com, via email at help@snowjoe.com or tweet us @snowjoe.

EXPORTS:

Customers who have purchased Snow Joe® + Sun Joe® products exported from the United States and Canada should contact their Snow Joe® + Sun Joe® distributor (dealer) to obtain information applicable to your country, province or state. If for any reason, you are not satisfied with the distributor's service, or if you have difficulty obtaining warranty information, contact your Snow Joe® + Sun Joe® seller. If in the event your efforts are unsatisfactory, please reach out to us directly.



sunjoe.com