



OPERATOR'S MANUAL

A Division of Snow Joe®, LLC

ELECTRIC GARDEN CULTIVATOR

6-INCH | 2.5-AMP

Model TJ599E-RM

Form No. SJ-TJ599E-RM-880E-V1

THANKS FOR YOUR PURCHASE OF A REMANUFACTURED PRODUCT.

To make sure you get the most out of your product, be sure to register online at

snowjoe.com

to enjoy full product support.

PASTE UPC LABEL HERE



ELECTRIC GARDEN CULTIVATOR

6-INCH | 2.5-AMP

OPERATOR'S MANUAL

A Division of Snow Joe®, LLC

Model TJ599E-RM

Form No. SJ-TJ599E-RM-880E-V1

IMPORTANT! Safety Instructions

All Operators Must Read These Instructions Before Use

Always follow these safety guidelines. Failure to do so may result in serious bodily injury or death.

General Safety WARNINGS!

You and any other operator of this garden cultivator must read, understand and follow these instructions in their entirety. Failure to follow these instructions may result in ELECTRIC SHOCK, FIRE and/or serious PERSONAL INJURY.

Notice the personal safety alert symbol  used in this manual to draw your attention to a WARNING given along with the particular operating instruction. This means that the operation requires special ATTENTION, CAUTION and AWARENESS.

- 1. Keep work area clean and well-lit** – Cluttered, dark areas invite accidents.
- 2. Replacement parts** – When servicing this unit, use only identical replacement parts. Replace or repair damaged cords immediately.
- 3. Keep children, bystanders and pets away** – All spectators, including pets, should be kept a safe distance away from the work area.
- 4. Know your product** – Know how to start and stop the machine. Be thoroughly familiar with the controls.
- 5. Use the right tool** – Do not use this machine for any job except that for which it is intended.
- 6. Dress properly** – Do not wear loose clothing or jewelry as such articles can become caught in moving parts. Wear a protective covering to contain long hair. Wearing rubber gloves and substantial non-slip footwear is recommended when working outdoors.
- 7. Extension cords** – To prevent electric shock, use only with an extension cord suitable for outdoor use.
- 8. Avoid accidental starting** – Do not carry the garden cultivator with your finger on the switch. Make sure the switch is off before plugging in the unit.

 **CAUTION!** Moving parts will continue to run for several seconds after turning off the machine.

- 9. Do not abuse the cord** – Never carry the garden cultivator by the cord or yank the cord to disconnect it from the receptacle. Keep the cord away from heat, oil and sharp edges.
- 10. Moving parts** – Keep hands and feet away from moving parts. Keep guards in place and in proper working order.
- 11. Do not force the tool** – It will perform better with less likelihood of personal or mechanical injury if it is used at the rate for which it was designed.
- 12. Do not overreach** – Keep proper footing and balance at all times.

If the garden cultivator strikes a foreign object, follow these steps:
 - **Stop the electric garden cultivator.**
 - **Inspect for damage.**
 - **Repair any damage before restarting and operating the garden cultivator.**
- 13. Use safety glasses** – Also use safety footwear, snug-fitting clothing, protective gloves, hearing and head protection.
- 14. Disconnect the tool** – Disconnect the garden cultivator from the power supply when it is not in use, before servicing it, when changing accessories and when performing any other maintenance task.
- 15. Store idle tool indoors** – When not in use, the garden cultivator should be stored indoors in a dry and high or locked-up place out of the reach of children.
- 16. Maintain the garden cultivator with care** – Keep the cutting edge sharp and clean for optimal performance and to reduce the risk of injury. Inspect the extension cord periodically and immediately replace it if damaged. Keep the handles dry, clean and free from oil and grease. Follow the additional recommendations described in the maintenance section of this manual.
- 17. Avoid dangerous environments** – Do not use the garden cultivator in rain, damp or wet locations. Do not operate the garden cultivator in gaseous or explosive atmospheres or use the garden cultivator near flammable or combustible liquids. Motors in these tools normally spark, and the sparks might ignite fumes.
- 18. Stay alert** – Watch what you are doing. Use common sense. Do not operate the garden cultivator when you are tired or under the influence of drugs, alcohol or other medication.
- 19. Check for damaged parts** – Before further use of the appliance, a guard or other part that is damaged should

be carefully checked to determine that it will operate properly and perform its intended function. Check for alignment of moving parts, binding of moving parts, breakage of parts, mounting, and any other condition that may affect its operation. A guard or other part that is damaged should be properly repaired or replaced. Contact the Snow Joe® + Sun Joe® customer service center at 1-866-SNOWJOE (1-866-766-9563) for assistance.

Training

- Read, understand and follow all instructions on the cultivator and in the manual before operating this unit. Thoroughly familiarize yourself with the controls and the proper use of the equipment. Know how to stop the unit and disengage the controls quickly.
 - Children should never be allowed access to the equipment. Adults should never operate the equipment without carefully reading and understanding these instructions.
 - Keep the area of operation clear of all persons, particularly small children and pets.
 - Exercise caution to avoid slipping or falling.
 - Always plan your cultivating pattern to avoid discharge of material toward people, pets and property. Thrown objects can cause serious personal injury.
 - Keep people, pets and property at least 25 feet from the cultivator while it is in operation. Stop the cultivator if people or pets enter the discharge area.
 - Always observe the surface conditions in order to avoid slipping, falling and unexpected objects.
- Ensure the controls (start/stop) function properly before cultivating.
 - Hold onto the cultivator with both hands during operation. Ensure the grips are dry.
 - Contact with the rotating parts can amputate hands and feet. Do not put hands or feet near rotating parts.
 - Plan your cultivating pattern to avoid discharge towards people or property (e.g., windows, cars etc.). Do not direct discharge at children, bystanders and pets or allow anyone in front of the machine.
 - Only operate the cultivator when there is good visibility or light and dry conditions. Always watch your footing and keep a firm hold on the grips. Walk don't run!
 - Do not operate the cultivator on slippery surfaces. Check your footing as you operate the cultivator.
 - Exercise caution when changing direction and operating on slopes. Always keep feet and legs a safe distance away from the machine. Look for hidden obstacles or hazards.
 - Do not overload machine capacity by attempting to cultivate to deeply. It will cause excessive resistance.
 - Stop the cultivator and disconnect the electric cord before you leave the operating position (behind the handles) to make any adjustments or inspections. Wait until the tines have come to a complete stop.
 - If the cultivator should start to vibrate abnormally, stop the machine and inspect thoroughly for damage.
 - Turn the machine OFF and disconnect the electrical power when moving to a new work area. Allow the tines to completely stop rotating before moving the cultivator.
 - Always use care and good judgment when you have a situation that is not covered in this manual. If unsure, always contact the distributors where you bought the cultivator or the nearest service location before proceeding.
 - Do not use in rain.
 - Do not grasp the exposed cutting blades or cutting edges when picking up or holding the appliance.

Preparation

- Always inspect the area where the cultivator is to be used. Remove all objects (e.g., stones, sticks, wires and foreign objects) that could be thrown by the tines or cause the operator to trip.
- Thrown objects can cause serious injury to the eyes and exposed body. Always wear safety glasses or eye shields during operation and while performing an adjustment or repair.
- Always operate cultivator wearing adequate garments. Do not wear jewelry or other loose clothing, which could become entangled in moving parts. Wear footwear that provides sure footing.
- Observe any noise-prevention regulations and laws.
- Inspect the cultivator for worn, missing or damaged parts and safety labels. See maintenance section for detailed instructions.

Operation

- Do not operate the machine while under the influence of alcohol or drugs.
- Keep all safety devices in place and in proper working order. Do not operate with missing or damaged components.

Work Stoppage

- Always turn the cultivator OFF and disconnect the electrical power when there is a work stoppage or changing work areas. Never leave the machine running when unattended.
- The tines will continue to rotate for a short period after turning the cultivator OFF. Wait until the tines have completely stopped before lifting the machine or conducting inspection and maintenance.
- The motor housing remains hot for a short period after the machine is turned OFF. Allow the motor housing to cool off before touching or storing near combustible material.

Maintenance + Storage

- Maintain or replace safety and instruction labels.
- Disengage all controls, stop the engine and wait until the tines come to a complete stop before cleaning, repairing or inspecting the cultivator.
- Regularly check the following:
 - i) Accumulation of debris around the tines could cause a poor performance or damage to the motor. Inspect and clean before every use.
 - ii) Safety devices are operating properly. Do not tamper with or adjust safety devices.
 - iii) Bolts and screws for proper tightness. Visually inspect machine for any damage and that the cultivator is in safe working condition.
 - iv) Always replace damaged parts with original equipment manufacturer's (OEM) parts only. Replacement parts that do not meet the original equipment specifications may lead to improper performance and compromise safety.

Double-Insulated Appliances

In a double-insulated appliance, two systems of insulation are provided instead of grounding. No grounding means is provided on a double-insulated appliance, nor should a means for grounding be added to the appliance. Servicing a double-insulated appliance requires extreme care and knowledge of the system, and should be performed only by qualified service personnel at an authorized Snow Joe® + Sun Joe® dealer. Replacement parts for a double-insulated appliance must be identical to the parts they replace. A double-insulated appliance is marked with the words "Double Insulation" or "Double Insulated." The symbol  (square within a square) may also be marked on the appliance.



DOUBLE-INSULATED: GROUNDING NOT REQUIRED. WHEN SERVICING, USE ONLY IDENTICAL REPLACEMENT PARTS.

This electric garden cultivator is double-insulated, eliminating the need for a separate grounding system. Use only identical replacement parts. Read the instructions before servicing double-insulated appliances. Use this garden cultivator only as described in this manual.

Electrical Safety

1. Ground fault circuit interrupter (GFCI) protection should be provided on the circuit(s) or outlet(s) to be used for this electric garden cultivator. Receptacles are available having built-in GFCI protection and may be used for this measure of safety.
2. To prevent electric shock, use only with an extension cord suitable for outdoor use, such as SW-A, SOW-A, STW-A, STOW-A, SJW-A, SJOW-A, SJTW-A, or SJTOW-A.

Before use, check that the extension cord is in good condition. When using an extension cord, make sure to use one heavy enough to carry the current your product will draw. For lengths more than 50 ft (15 m), a No.14 AWG (or greater) extension cord should be used. An undersized cord will cause a drop in line voltage resulting in loss of power and overheating.



WARNING



Electric shock may cause SEVERE INJURY or DEATH. Heed these warnings:

- Do not allow any part of the electric garden cultivator to make contact with water while it is in operation. If the appliance becomes wet while turned off, wipe dry before starting.
- Use only a UL-, CSA-, or ETL-rated extension cord for outdoor, all-weather use.
- Do not use an extension cord over 100 ft (30 m).
- Do not touch the appliance or its plug with wet hands or while standing in water. Wearing rubber boots offers some protection.

EXTENSION CORD CHART

Extension Cord Length	Up to 50 ft (15 m)	+50 ft - 100 ft (+15 m - 30 m)
Wire Gauge (A.W.G.):	16	14

3. To reduce the risk of electric shock, this appliance has a polarized plug (i.e. one blade is wider than the other). Use this appliance only with a polarized UL-, CSA- or ETL-listed extension cord recommended for outdoor, all-weather use.

The appliance plug will fit into a polarized extension cord only one way. If the appliance plug does not fit fully into the extension cord, reverse the plug. If the plug still does not fit, obtain a correct polarized extension cord. A polarized extension cord will require the use of a polarized wall outlet. The extension cord plug will fit into the polarized wall outlet only one way. If the plug does not fit fully into the wall outlet, reverse the plug. If the plug still does not fit, contact a qualified electrician to install the proper wall outlet. Do not modify the appliance plug, extension cord receptacle or extension cord plug in any way.

4. To prevent the appliance cord from disconnecting from the extension cord during operation, use the onboard extension cord restraint hook and/or make a knot with the two cords as shown in Table 1.

Table 1. Method of Securing Extension Cord

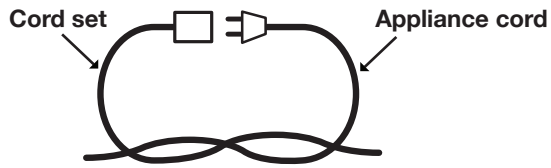

(A) Tie cord as shown

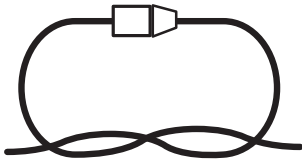











(B) Connect plug and receptacle

5. Do not abuse the cord. Never pull the garden cultivator by the cord or yank the cord to disconnect it from the receptacle. Keep the cord away from heat, oil, and sharp edges.

Safety Symbols

The following table depicts and describes safety symbols that may appear on this product. Read, understand, and follow all instructions on the machine before attempting to assemble and operate.

Symbols	Descriptions	Symbols	Descriptions
	READ THE OPERATOR'S MANUAL(S) – Read, understand and follow all instructions in the user manual(s) before attempting to assemble and operate.		Wear eye protection, breathing protection and ear protection (i.e. safety goggles, dust masks and ear defenders).
	SAFETY ALERT – Indicates a precaution, a warning or a danger.		WARNING! Do not expose the unit to rain or wet conditions.
	WARNING! Keep electrical extension cord away from tines.		WARNING! Rotating parts may cause serious injury. Make sure the tines come to a complete stop before transporting the machine or before inspecting, cleaning or conducting any other maintenance.
	SWITCH OFF! Remove plug from the outlet before cleaning or conducting maintenance checks.		SWITCH OFF! Remove plug from the outlet immediately if the cord is damaged or cut.
	Beware of foreign objects that could be thrown from the appliance. Keep bystanders a safe distance away from the work area.		DOUBLE INSULATION – When servicing, use only identical replacement parts.

Know Your Electric Garden Cultivator

Read the owner's manual and safety instructions carefully before operating the electric garden cultivator. Compare the illustration below to the electric garden cultivator in order to familiarize yourself with the location of the various controls and adjustments. Save this manual for future reference.

- 1. Trigger switch
- 2. Operating handle
- 3. Safety lock button
- 4. Auxiliary handle
- 5. Locking knob
- 6. Extension cord restraint hook
- 7. Appliance cord
- 8. Telescoping tube
- 9. Adjustable slide lock button
- 10. Shroud
- 11. Air outlet
- 12. Steel blade tines

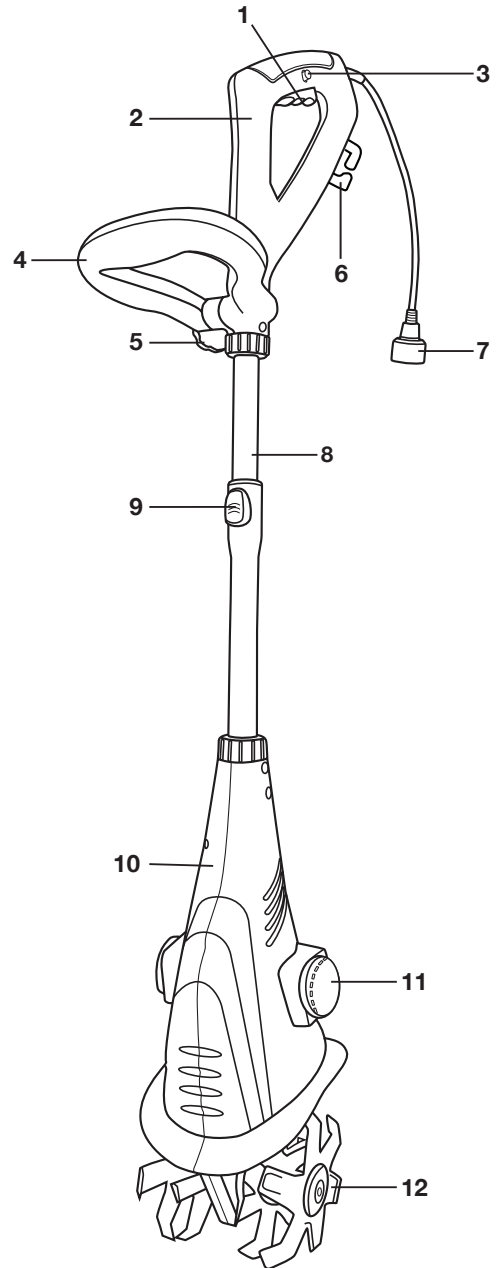

Technical Data

Rated Voltage	120 V ~ 60 Hz	Rotor	4 steel tilling blades
Power	2.5 A	Cultivating Width (Max)	6.3 in. (16 cm)
No Load Speed	300 rpm (approx.)	Cultivating Depth (Max)	6 in. (15 cm)
Telescoping Shaft	46 in. to 53 in. (116.8 cm to 135 cm)	Weight	10 lbs (4.6 kg)

Unpacking

Carton Contents

- Electric cultivator housing
- Auxiliary handle
- Locking knob
- Manual with registration card

1. Carefully remove the electric cultivator and check to see that all of the above items are supplied.
2. Inspect the product carefully to make sure no breakage or damage occurred during shipping. If you find damaged or missing parts, DO NOT return the unit to the store. Please call the Snow Joe® + Sun Joe® customer service center at 1-866-SNOWJOE (1-866-766-9563).

NOTE: Do not discard the shipping carton and packaging material until you are ready to use the electric cultivator. The packaging is made of recyclable materials. Properly dispose of these materials in accordance with local regulations or save the packaging for long-term product storage.

IMPORTANT! The equipment and packaging material are not toys. Do not let children play with plastic bags, foils, or small parts. These items can be swallowed and pose a suffocation risk!

Assembly

⚠ WARNING! Always disconnect the power cord prior to disassembling or mounting of parts and accessories in order to reduce the risk of injury. Use of any other parts not recommended and can result in injury.

Machine Body and Handle Assembly

1. Unpack the cultivator, auxiliary handle, and locking knob (Fig. 1).

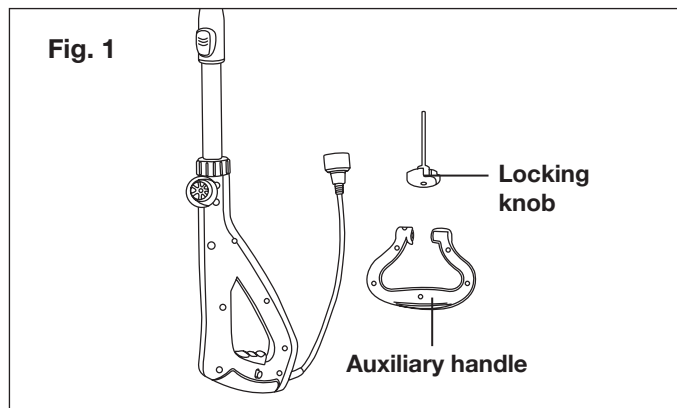

2. Snap the auxiliary handle onto the machine (Fig. 2).
3. Insert the locking knob through the auxiliary handle, and screw tightly (Fig. 2). The angle of the auxiliary handle can be adjusted by loosening the locking knob, re-positioning the handle, and tightening the knob.

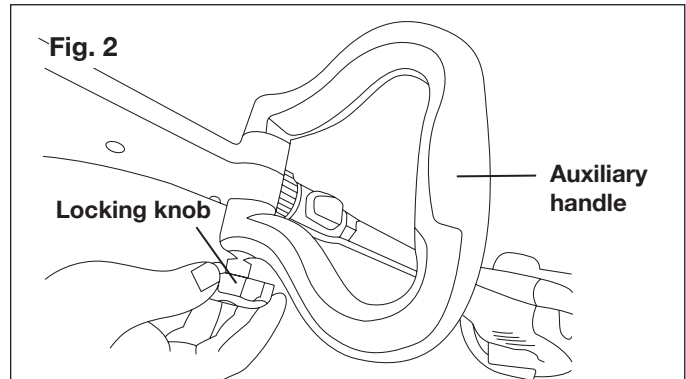

⚠ WARNING! To reduce the risk of damage or injury, only use tines that are manufactured for use with this cultivator. Do not use any other type of tines.

Operation

NOTE: Before using this cultivator, make sure that the power source you will use complies with the specifications detailed in this manual.

This machine is intended for breaking up and cultivating coarse soil for the purpose of mixing in fertilizer, peat and compost in domestic areas. Any use other than that specifically named in this manual may lead to damage to the tool and/or present a serious hazard to the operator.

The operator or user of the tool is responsible for any damage or injury caused to other persons or property. Only adults should operate the cultivator. Children and persons unfamiliar with the manual must not be allowed to use the tool. Do not use the tool in rain or damp surroundings. The manufacturer shall not be held liable for damage arising from improper use or incorrect operation of the cultivator.

⚠ WARNING!

- Keep hands away from blades.
- Disconnect the power cord and wait for blades to come to a complete stop before making any adjustments, cleaning or removing debris from blades. NEVER try to remove an obstruction from the blades while the cultivator is plugged in.
- Be sure all adjustments knobs, screws or levers are tight and secure before use.
- Be aware of extension cord while operating the cultivator. Be careful not to trip over cord. Keep cord away from tines at all times.

⚠️ WARNING! Carelessness, mishandling or error on the part of the operator may result in bodily injury (e.g. amputation, projectile impact, or death). The cultivator must be operated according to the warnings and guidelines in this manual.

Powering ON + OFF

1. To power ON, first grip the upper handle. Use your thumb to press the safety lock button, then squeeze the trigger switch and release the safety lock button (Fig. 3).
2. To power OFF, release the trigger switch (Fig. 3).

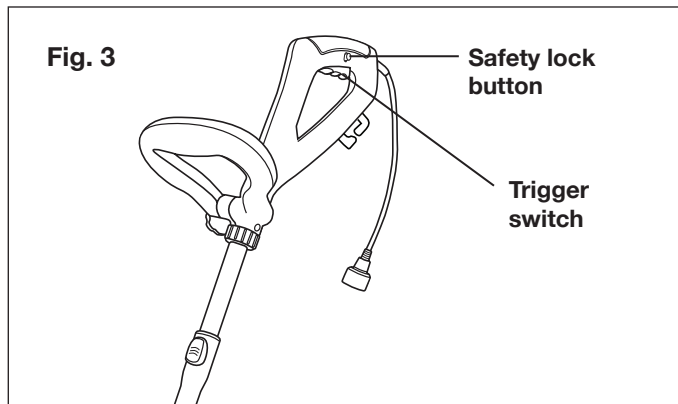

Adjusting the Telescoping Tube

1. Disconnect the cultivator from the power supply.
2. Push the adjustable slide lock button and extend the tube to the desired length (Fig. 4).

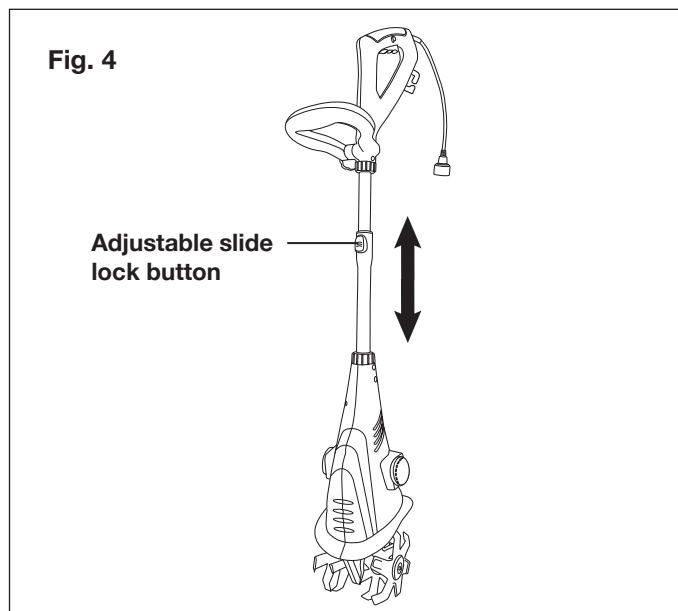

3. Lock the tube in position by releasing the slide lock button.

⚠️ WARNING! Failure to lock the telescopic tube as directed could result in personal injury.

Operating Tips

⚠️ CAUTION!

- Check the area to be tilled or cultivated. Look for any hazards and obstructions that could contribute to unsafe conditions.
- Remove all rocks, debris, and other materials that could become jammed in the tines.
- If the cultivator stops due to a rock or other obstruction becoming jammed in the tines, you must first unplug the power cord before removing the blockage.
- Do not till or cultivate in areas where there may be hidden hazards, such as sprinkler heads and pipes, buried power cables or gas lines or other similar hazards.
- Do not operate the cultivator on a slope that is too steep for safe operation.
- Make sure your footing is firm. Keep your feet apart. Divide your weight evenly on both feet.

Operating the Electric Cultivator

⚠️ WARNING! Rotating tines may cause serious injury.

The tines will continue to turn for a few seconds after the tool has been switched OFF. Do not touch the rotating tines. Contact with hot components (i.e. motor housing or gear box) on the machine may cause burns. Allow the machine to cool off before handling.

NOTE: Use the cultivator for breaking sod, preparing seed beds, and for cultivating gardens and flower beds. The unit can also dig small holes for planting sapling or potted plants.

Guide the cultivator using light pressure. Do not force tool. It will do the job better and safer at the rate for which it was intended.

1. Walk the electric cultivator through the soil at a normal pace and in as straight a line as possible. Move the unit slowly forward and back in a rocking motion, first pulling it backward then letting it "crawl" forward. Repeat this motion to till deeper into soil.
2. Always till away from the electrical outlet. Ensure the extension cord is kept away from the work area.
3. Do not try to till too deeply or force the unit into soil that is extremely hard or resistant.

Note: Overloading the machine will cause it to shut down. If this occurs the machine will not operate until the motor has completely cooled down. This is normal and the cultivator will reset itself.

4. Always maintain a firm grip on the electric cultivator.
5. Lift the electric cultivator over hard surfaces. Never lift or drag the electric cultivator when the motor is running.

Changing the Tines

NOTE: The tines in the motor housing are provided by the manufacturer. Only use tines that have been supplied by the manufacturer. Ensure the tines are in good condition prior to operation.

To replace the tines, using the following procedure:

1. Turn OFF the cultivator and unplug the power cord.
2. Place the unit on a flat surface and stand in a safe position.
3. Remove the locknut with a socket wrench and disassemble the blades (Fig. 5).

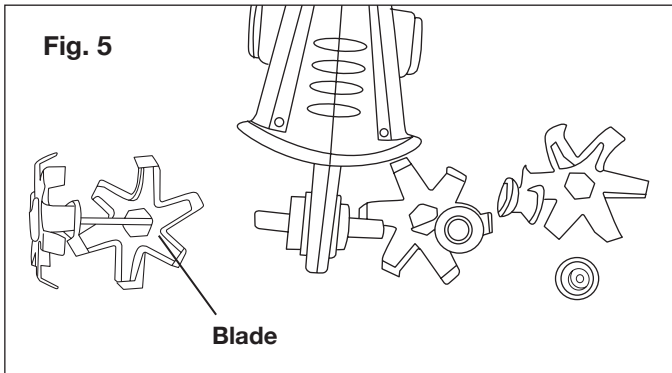

4. Remove the old blades while taking note of the sequence of assembly. Install the new blades in the order they were prior to disassembly. Tighten with the locknut. (Figs. 6 – 11).

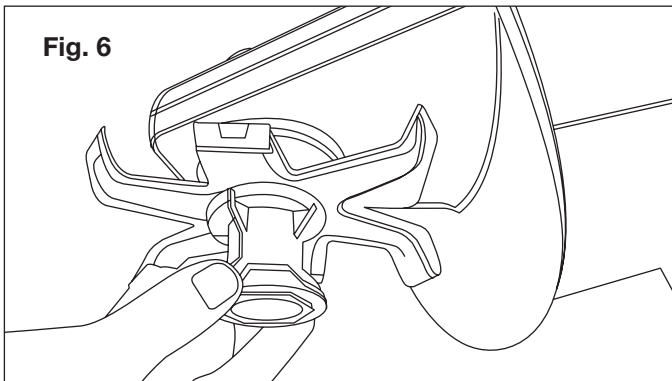

IMPORTANT: The tines must be set in the correct turning direction. Note the position of the original tines, and replace them in the exact same direction.

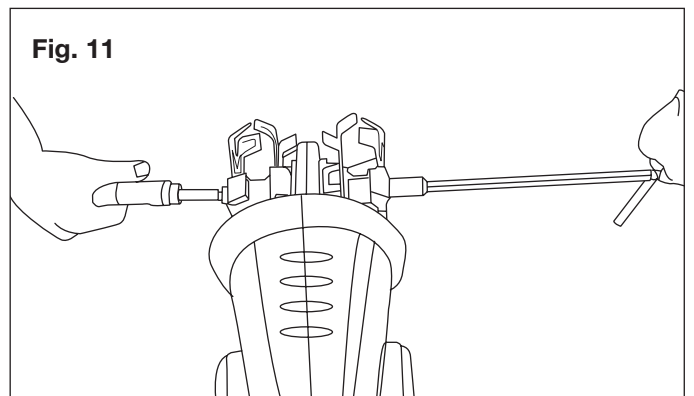
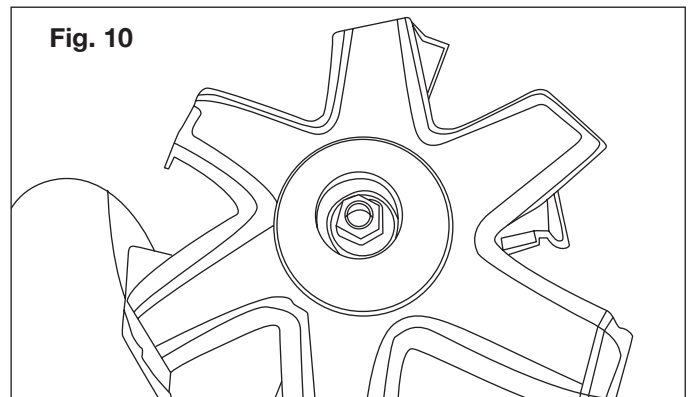
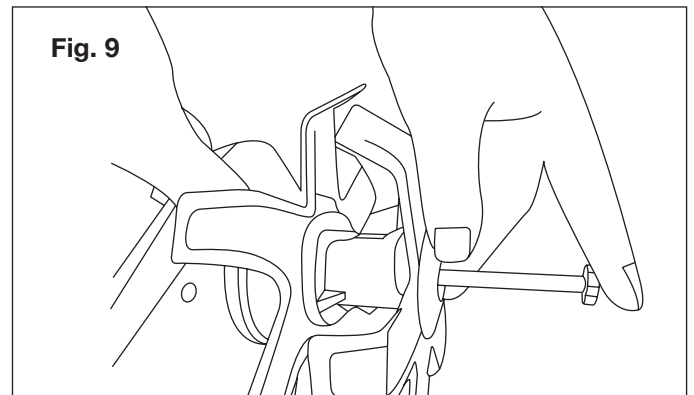
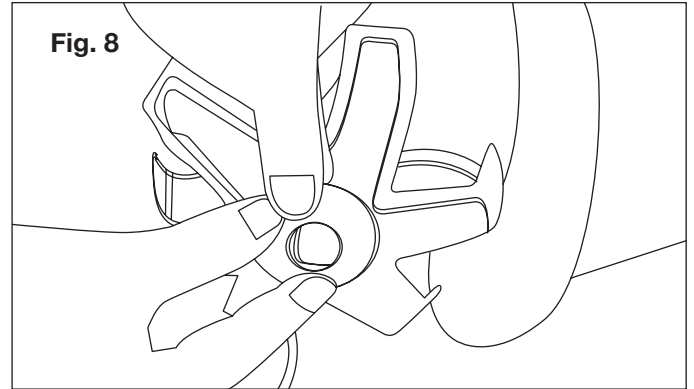
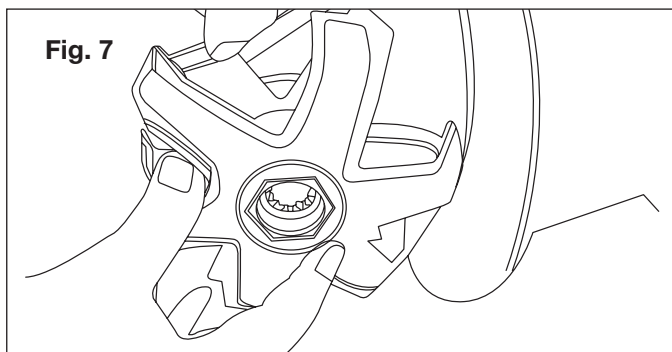

5. Only use tines that are produced by the manufacturer.

Cleaning, Maintenance + Storage

⚠️ WARNING! Unexpected tine movement may cause personal injury. Before servicing, repairing or inspecting the unit, turn the motor OFF and disconnect the extension cord. Wait for the tines to completely stop rotating before conducting inspection, cleaning or maintenance.

⚠️ WARNING! Contact with hot components (i.e. motor housing or gear box) on the machine may cause burns. Allow the machine to cool off before handling.

IMPORTANT!

- Wear protective gloves when cleaning or maintaining the machine.
- Do not use cleaning fluids or solvents or spray the machine down with water (especially pressurized water) when cleaning the machine.

NOTE: After each use, follow these steps when cleaning the machine:

1. Remove soil, dirt and foliage stuck in the tines, driveshaft, tool surface and vents with a brush or dry cloth.
2. Spray or rub biodegradable oil into the tines.
3. Clean soiled grips with a damp cloth.

Always inspect the machine for damaged and worn parts after each use. Check that safety features (labels, guards) are in place. Check that nuts, bolts and screws are tight.

Optional Accessories

⚠️ WARNING! ALWAYS use only authorized Snow Joe® + Sun Joe® replacement parts and accessories. NEVER use replacement parts or accessories that are not intended for use with this electric garden cultivator. Contact Snow Joe® + Sun Joe® if you are unsure whether it is safe to use a particular replacement part or accessory with your electric tiller + cultivator. The use of any other attachment or accessory can be dangerous and could cause injury or mechanical damage.

NOTE: Accessories are subject to change without any obligation on the part of Snow Joe® + Sun Joe® to provide notice of such changes. Accessories can be ordered online at snowjoe.com or via phone by contacting the Snow Joe® + Sun Joe® customer service center at 1-866-SNOWJOE (1-866-766-9563).

Service + Support

If your Sun Joe® TJ599E-RM electric garden cultivator requires service or maintenance, please call the Snow Joe® + Sun Joe® customer service center at 1-866-SNOWJOE (1-866-766-9563).

Model + Serial Numbers

When contacting the company, reordering parts or arranging service from an authorized dealer, you will need to provide the model and serial numbers, which can be found on the decal located on the housing of the unit. Copy these numbers into the space provided below.

Record the following numbers from the housing or handle of your new product:	
Model #:	
T J 5 9 9 E - R M	
Serial #:	



SNOW JOE® + SUN JOE® REFURBISHED GOODS WARRANTY

GENERAL CONDITIONS:

Snow Joe® + Sun Joe® operating under Snow Joe®, LLC warrants this refurbished product to the original purchaser for 90 days against defects in material or workmanship when used for normal residential purposes. If a replacement part or product is needed, it will be sent free of charge to the original purchaser except as noted below.

The duration of this warranty applies only if the product is put to personal use around the household. It is the owner's responsibility to correctly perform all maintenance and minor adjustments explained in the owner's manual.

HOW TO OBTAIN YOUR REPLACEMENT PART OR PRODUCT:

To obtain a replacement part or product, please visit snowjoe.com/help or email us at help@snowjoe.com for instructions. Please be sure to register your unit beforehand to speed up this process. Certain products may require a serial number, typically found on the decal affixed to the housing or guard of your product. All products require a valid proof of purchase.

EXCLUSIONS:

- Wearing parts like belts, augers, chains and tines are not covered under this warranty. Wearing parts can be purchased at snowjoe.com or by calling 1-866-SNOWJOE (1-866-766-9563).
- Batteries are covered in full for 90-days from the date of purchase.

Snow Joe® + Sun Joe® may from time to time change the design of its products. Nothing contained in this warranty shall be construed as obligating Snow Joe® + Sun Joe® to incorporate such design changes into previously manufactured products, nor shall such changes be construed as an admission that previous designs were defective.

This warranty is intended to cover product defects only. Snow Joe®, LLC is not liable for indirect, incidental or consequential damages in connection with the use or misuse of the Snow Joe® + Sun Joe® products covered by this warranty. This warranty does not cover any cost or expense incurred by the purchaser in providing substitute equipment or service during reasonable periods of malfunction or non-use of this product while waiting for a replacement part or unit under this warranty. Some states do not allow exclusions of incidental or consequential damages so the above exclusions may not apply in all states. This warranty may give you specific legal rights in your state.

HOW TO REACH US:

We're here to help Monday through Friday from 9AM to 6PM EST. You can reach us at 1-866-SNOWJOE (1-866-766-9563), online at snowjoe.com, via email at help@snowjoe.com or tweet us @snowjoe.

EXPORTS:

Customers who have purchased Snow Joe® + Sun Joe® products exported from the United States and Canada should contact their Snow Joe® + Sun Joe® distributor (dealer) to obtain information applicable to your country, province or state. If for any reason, you are not satisfied with the distributor's service, or if you have difficulty obtaining warranty information, contact your Snow Joe® + Sun Joe® seller. If in the event your efforts are unsatisfactory, please reach out to us directly.



snowjoe.com

⚠️WARNING! This product or its power cord contains chemicals, including lead, known to the State of California to cause cancer and birth defects or other reproductive harm. Wash hands after handling. For more information go to www.P65Warnings.ca.gov.

⚠️WARNING! Some dust created by power sanding, sawing, grinding, drilling, and other construction activities contains chemicals known [to the State of California] to cause cancer, birth defects, or other reproductive harm. Some examples of these chemicals are:

- lead from lead-based paints,
- crystalline silica from bricks and cement and other masonry products, and
- arsenic and chromium from chemically-treated lumber.

Your risk from these exposures varies, depending on how often you do this type of work. To reduce your exposure to these chemicals: work in a well ventilated area, and work with approved safety equipment, such as those dust masks that are specifically designed to filter out microscopic particles. For more information go to www.P65Warnings.ca.gov.